

Серия «Рабочие тетради дошкольника»

Обучение грамоте

(часть 1)

Для
детей
5-6
лет



Солнечные
ступеньки®

Уважаемые родители и педагоги!

Предлагаем вашему вниманию серию тетрадок для дошкольного образования «Солнечные ступеньки».

Перед вами тетрадь по обучению грамоте детей старшего дошкольного возраста.

Занимаясь по тетрадке «Солнечные ступеньки», дети смогут познакомиться с гласными и согласными буквами, научатся их писать, а также составлять и читать слоги. Выполняя задания, ребенок развивает координацию движений рук и пальцев, совершенствуя речевое развитие, внимание, память, мышление.

Данная методика овладения навыками письма используется на протяжении 10 лет.

Каждое занятие – новая солнечная ступенька к вершине дошкольных знаний!

Тысячи детишек, обучаясь по данным тетрадкам, смогли успешно поступить в самые престижные школы и лицеи.

Встретимся на «Солнечных ступеньках»!

Желаем успеха!

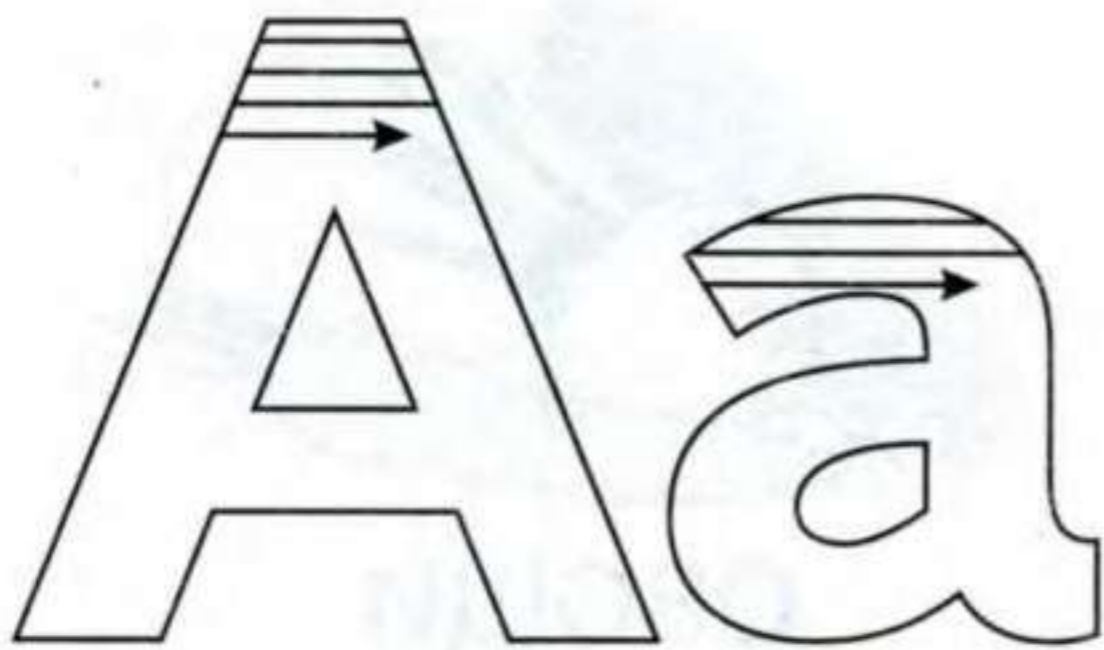

АИСТ

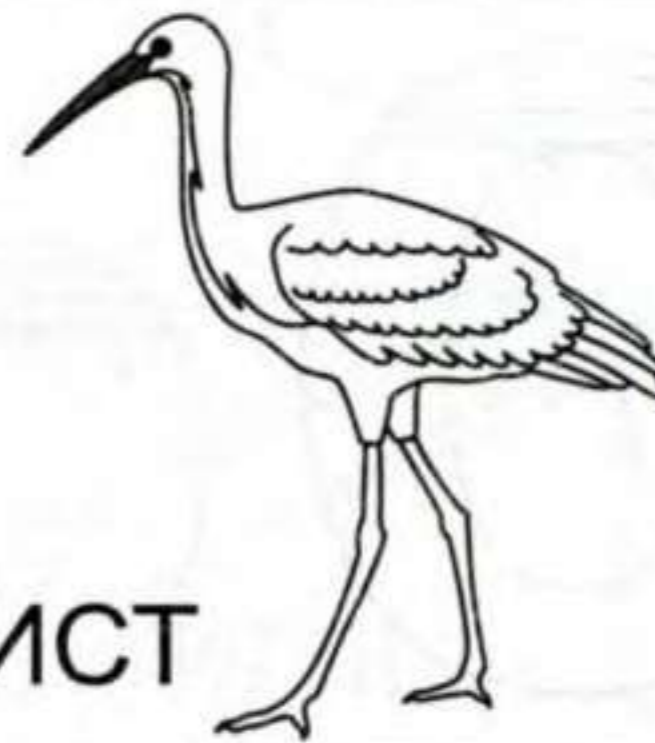

Найди и раскрась те предметы, названия которых начинаются на букву **А**.

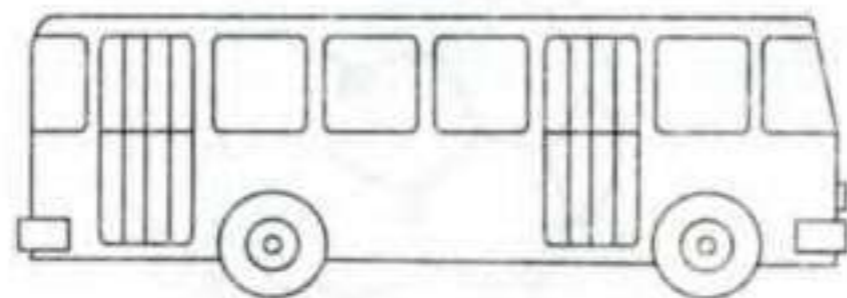
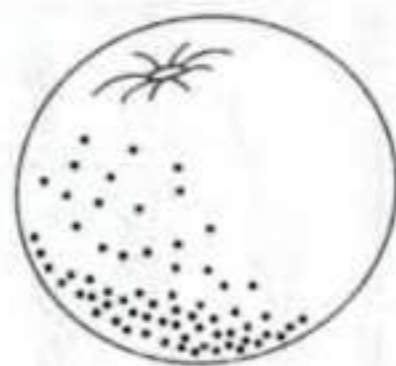
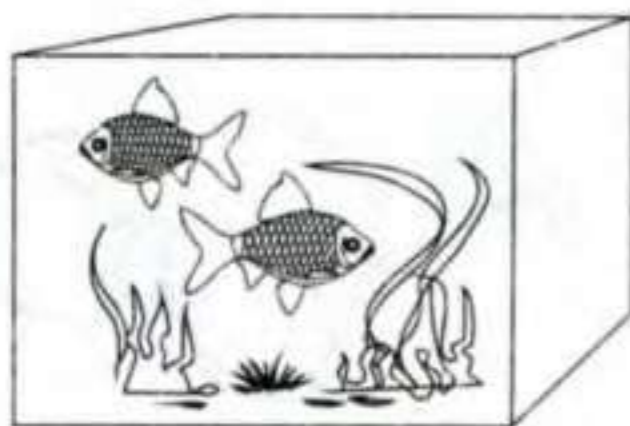

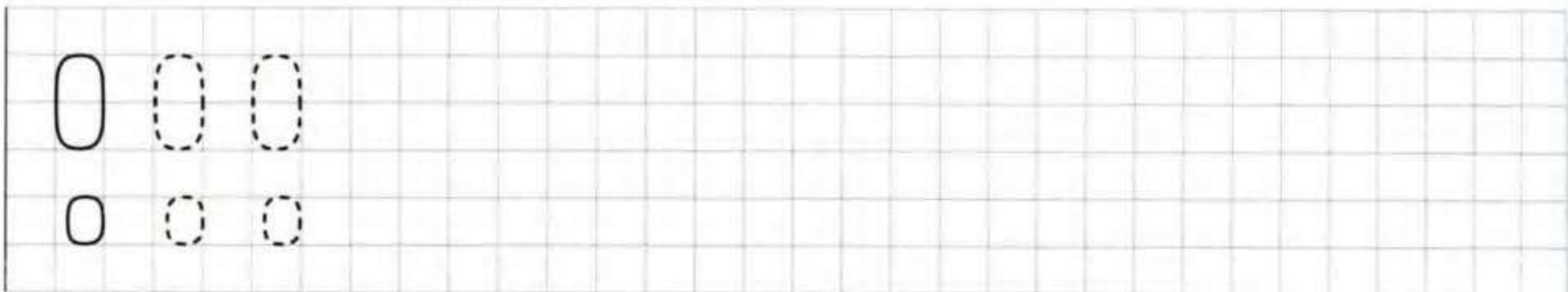
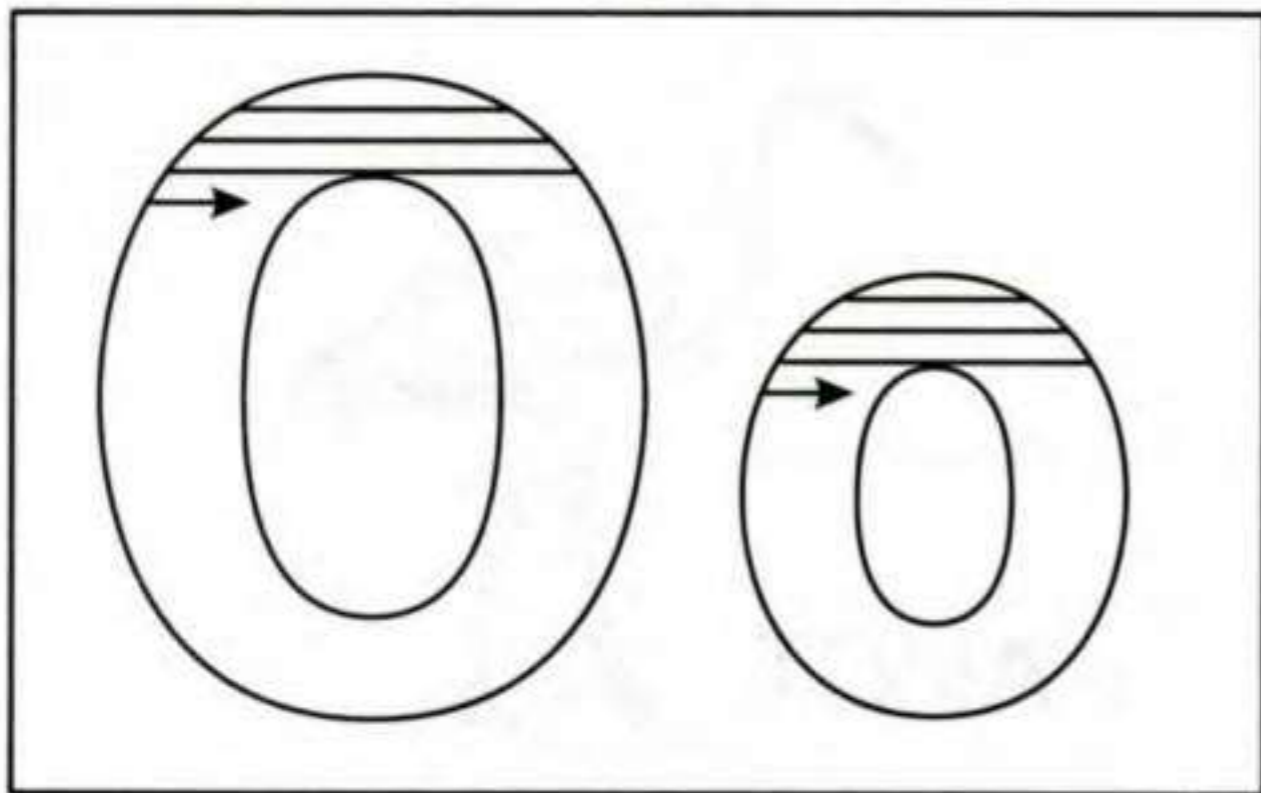

Найди и раскрась те предметы, названия которых начинаются на букву **О**.

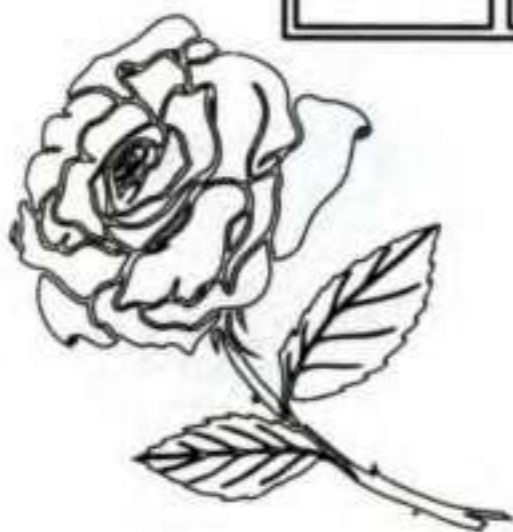
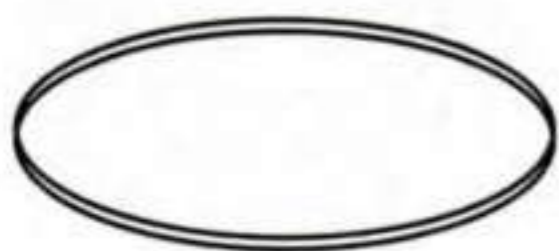
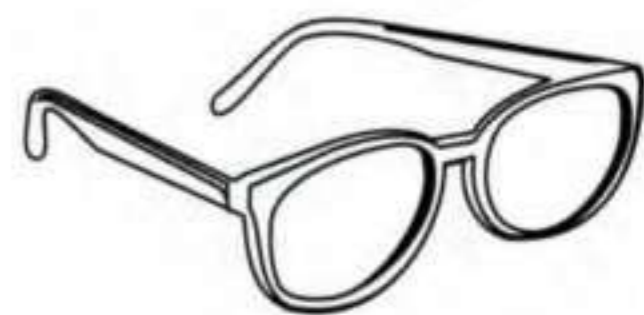
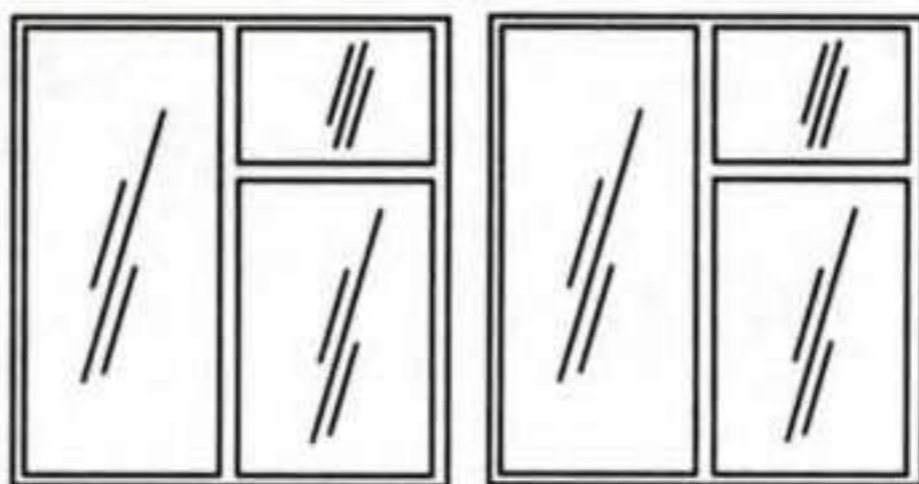
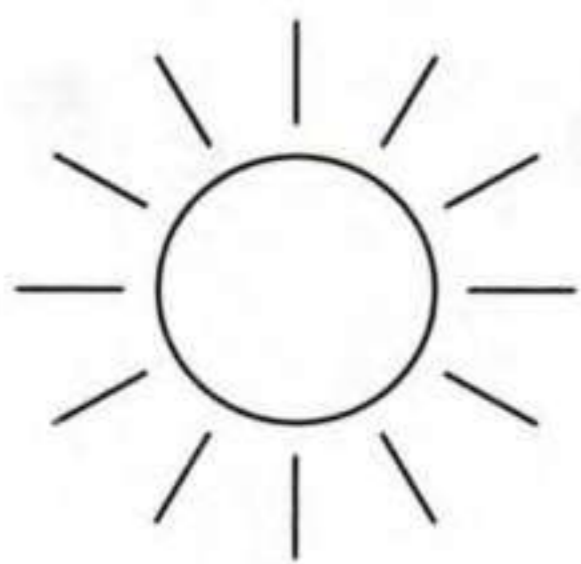

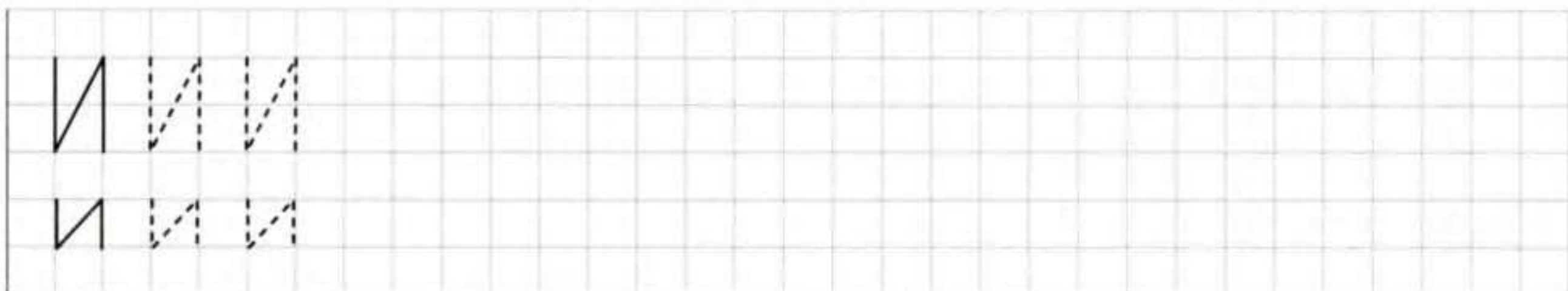
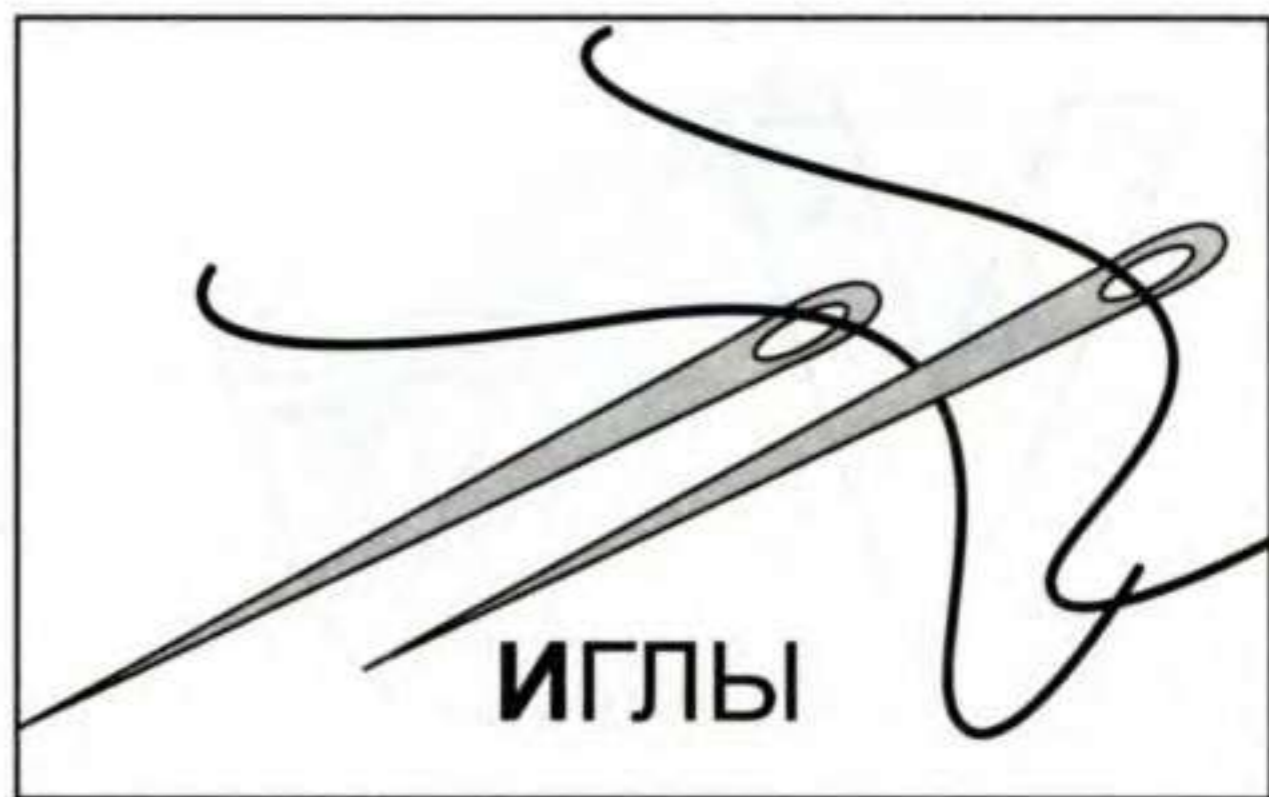
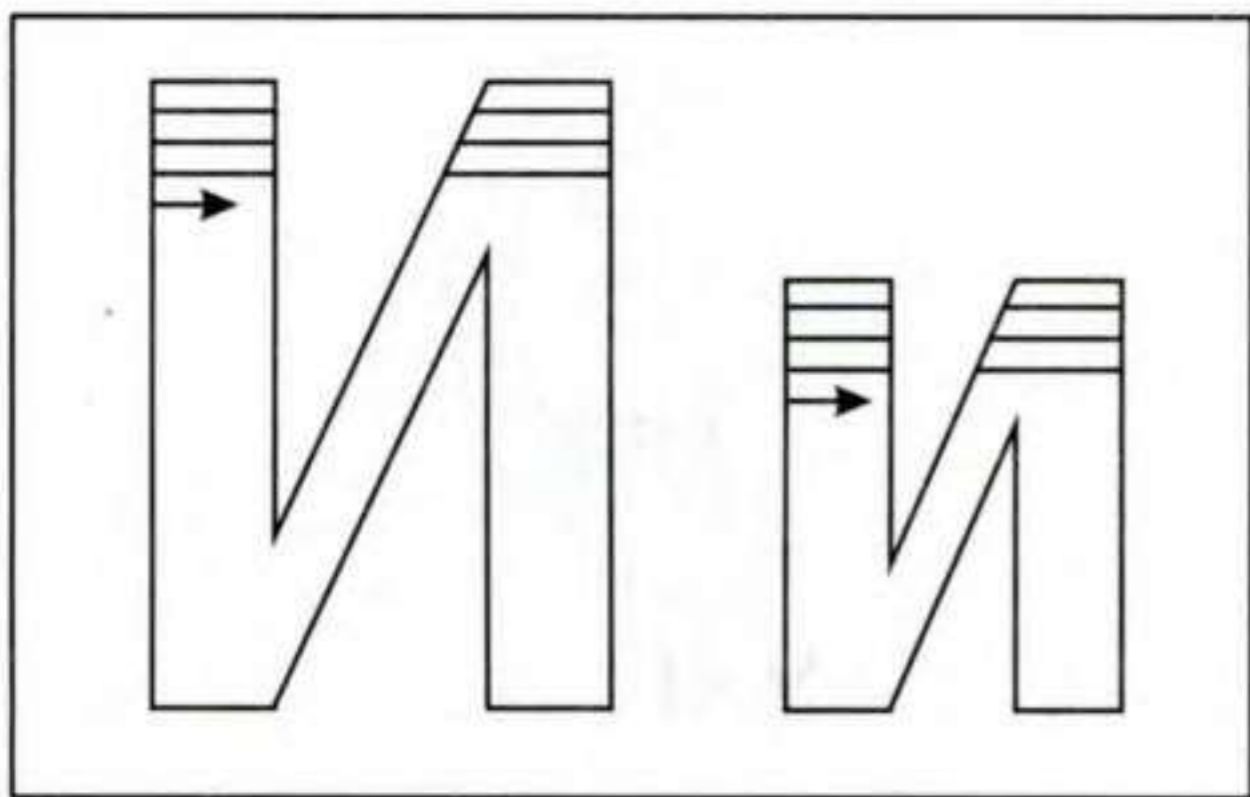

Букву **И** обведи в кружок, букву **О** зачеркни, букву **А** подчеркни.

А **И** **О** **И** **А** **А** **И**
О **и** **о** **и** **О** **А** **и** **О**
А **И** **А** **А** **А** **и**
А **и** **О** **А** **О** **А**

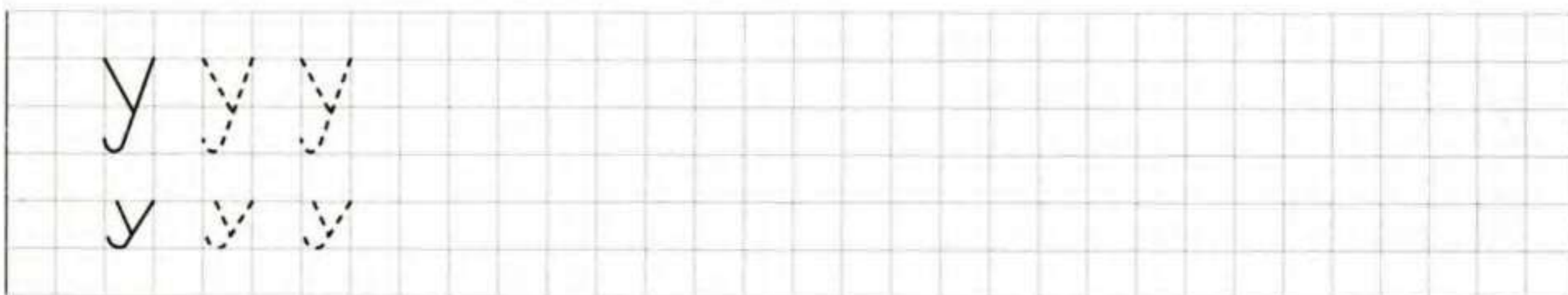
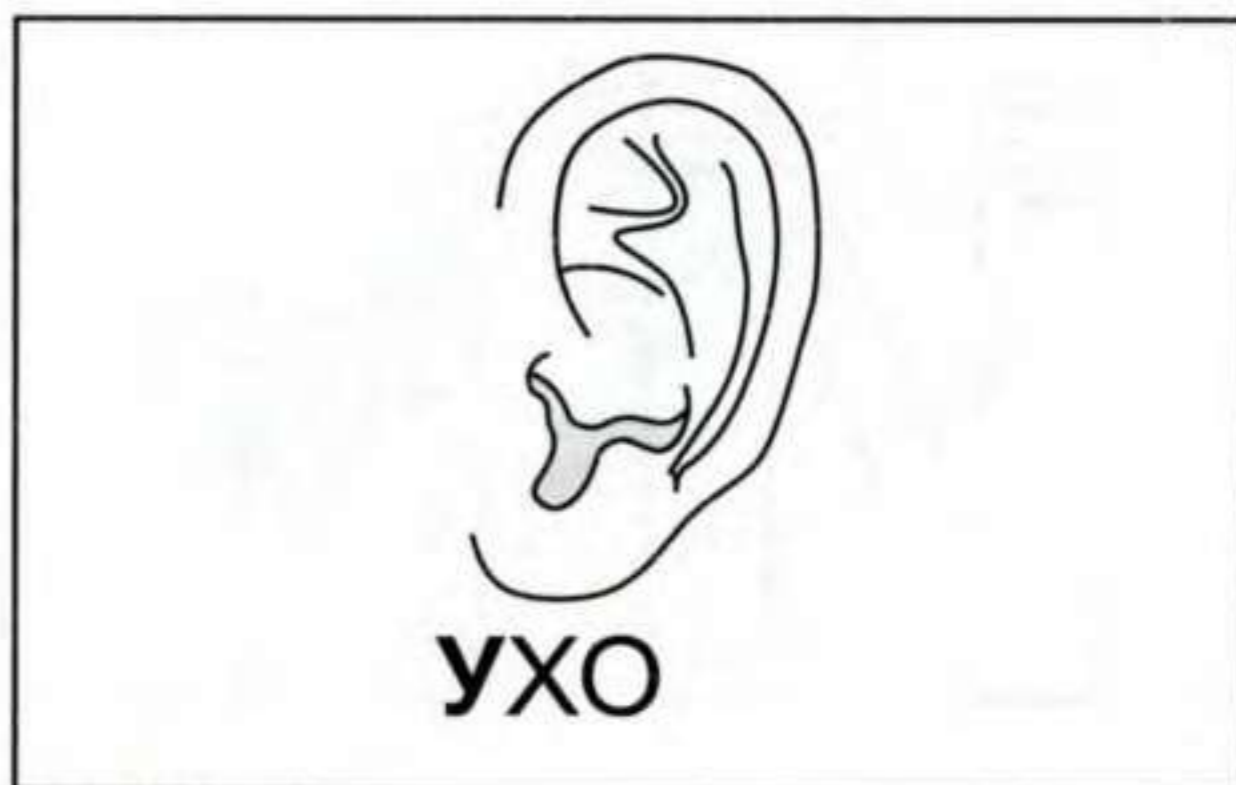
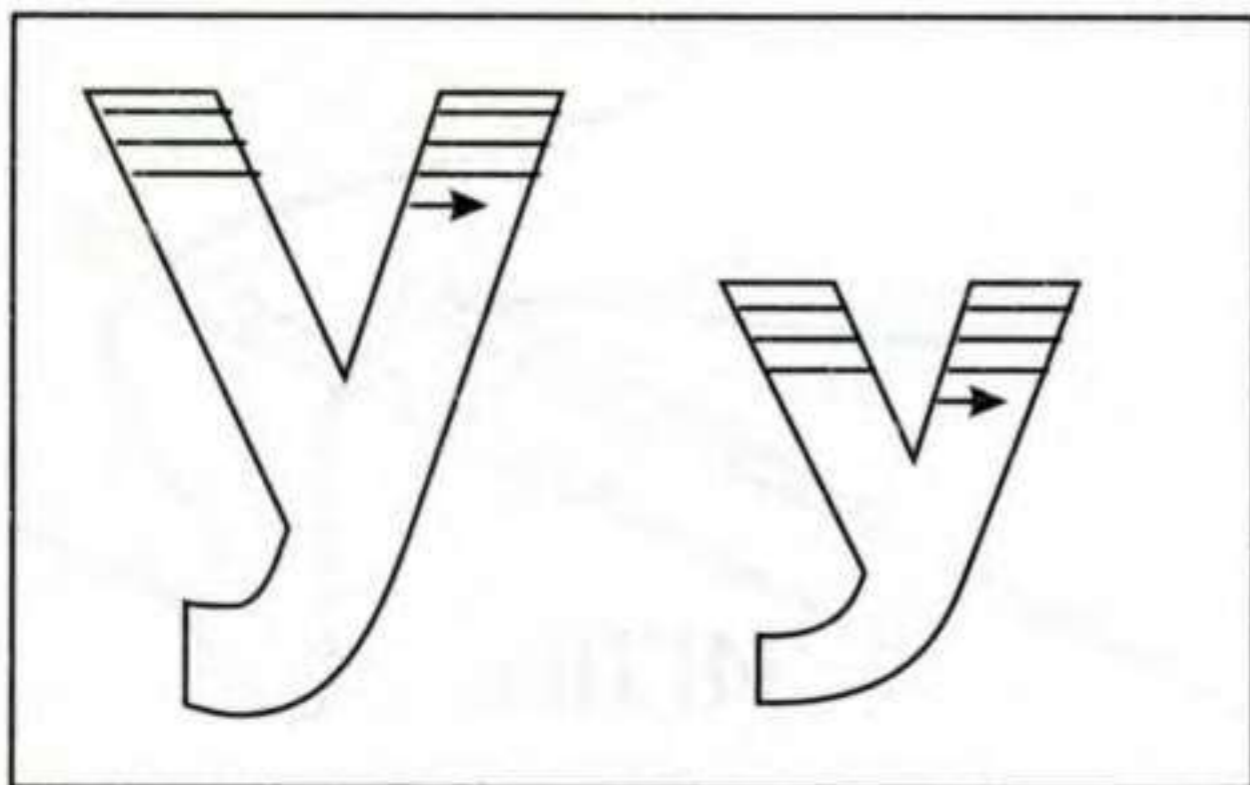

Прочитай, кто что произносит?

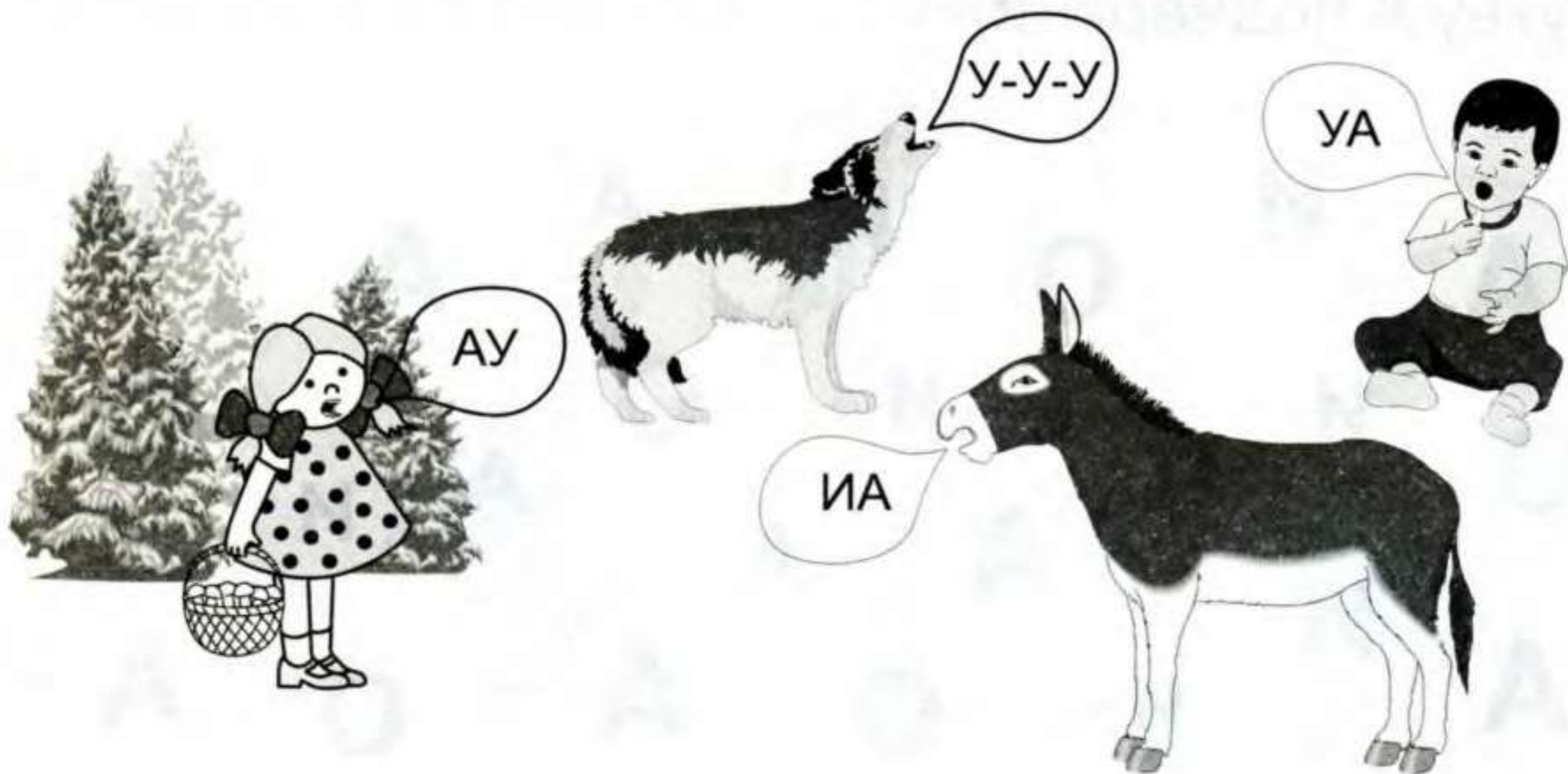

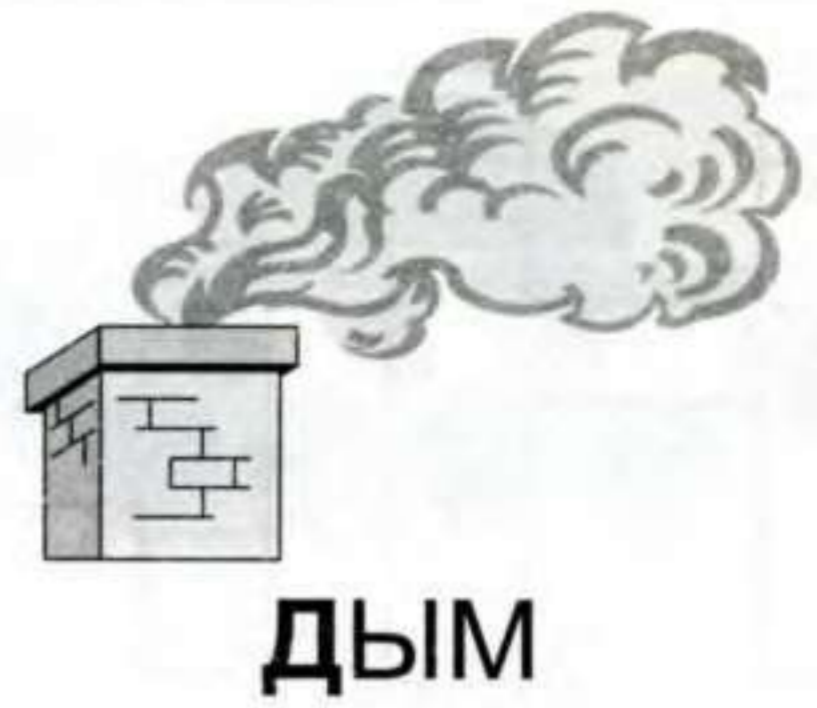
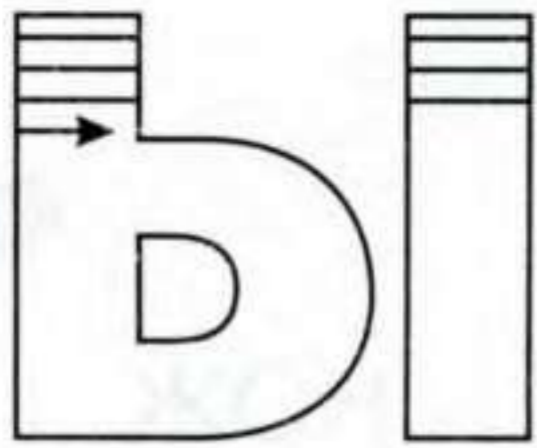

Ы Ы Ы

Раскрась только те предметы, в названии которых есть буква **Ы**.

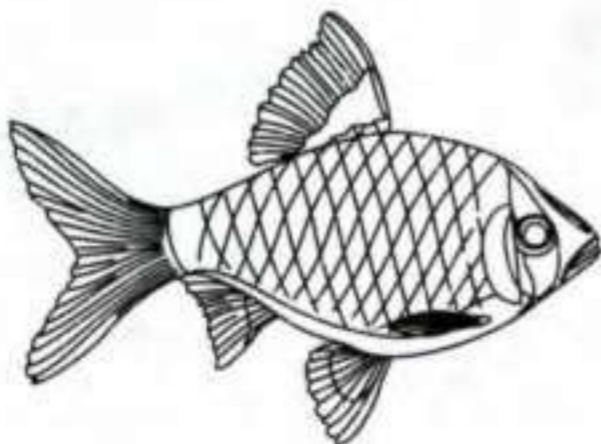
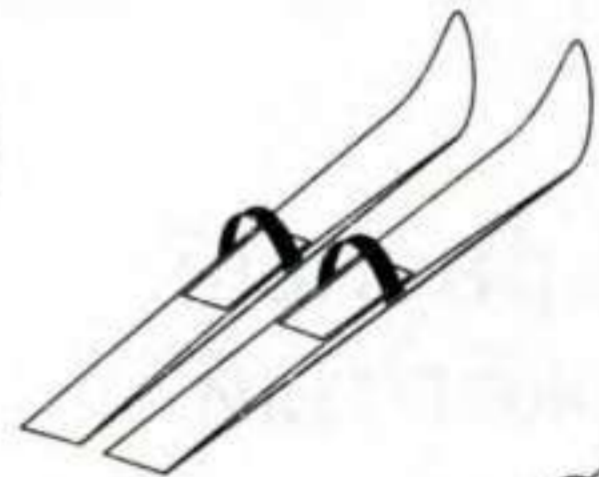
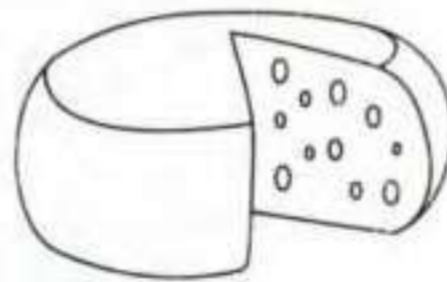
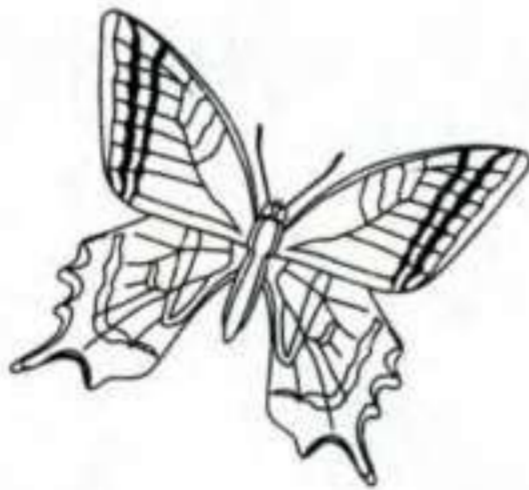
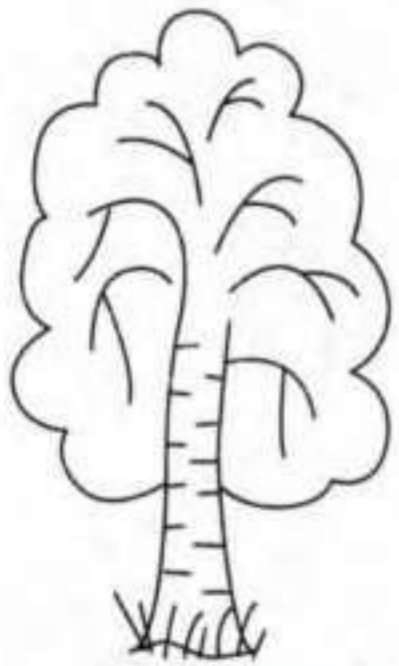

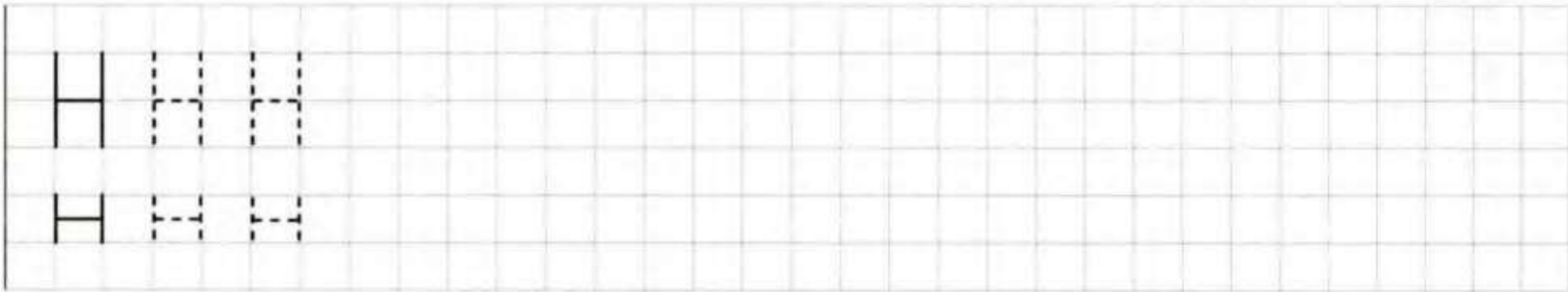
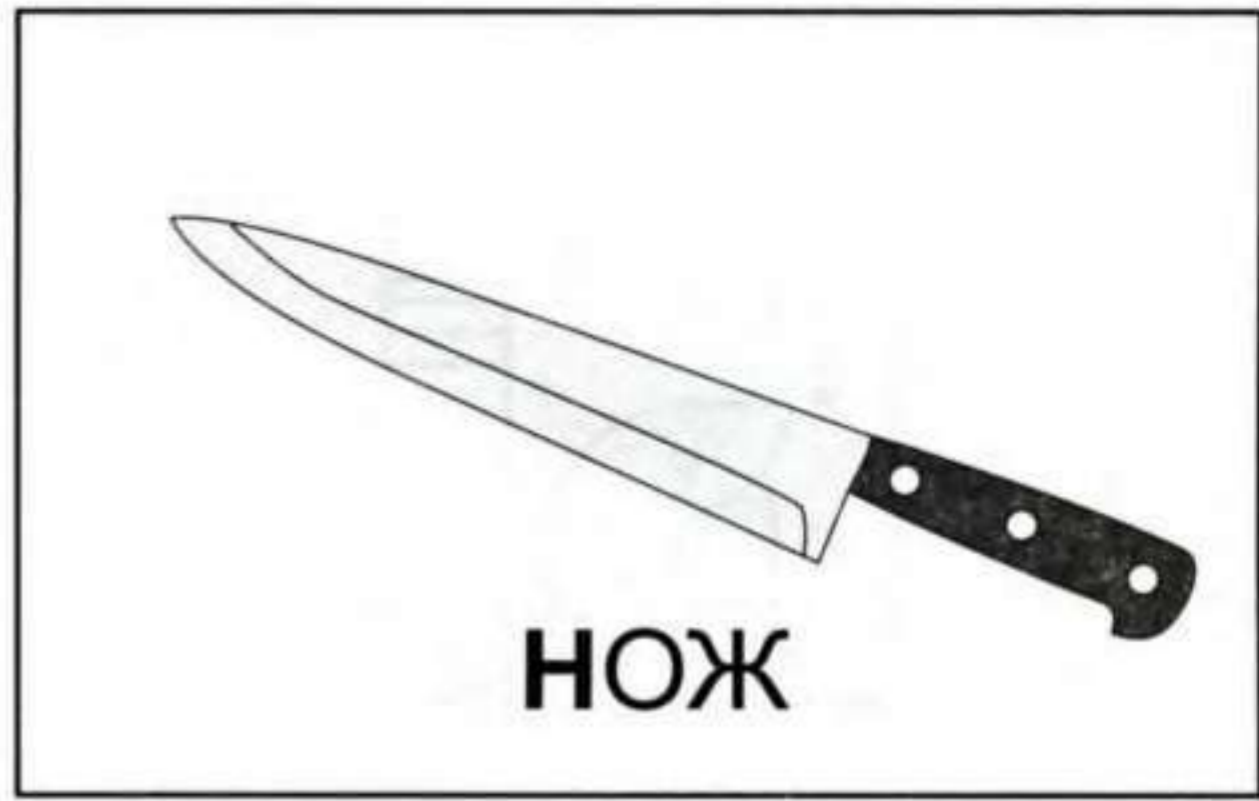
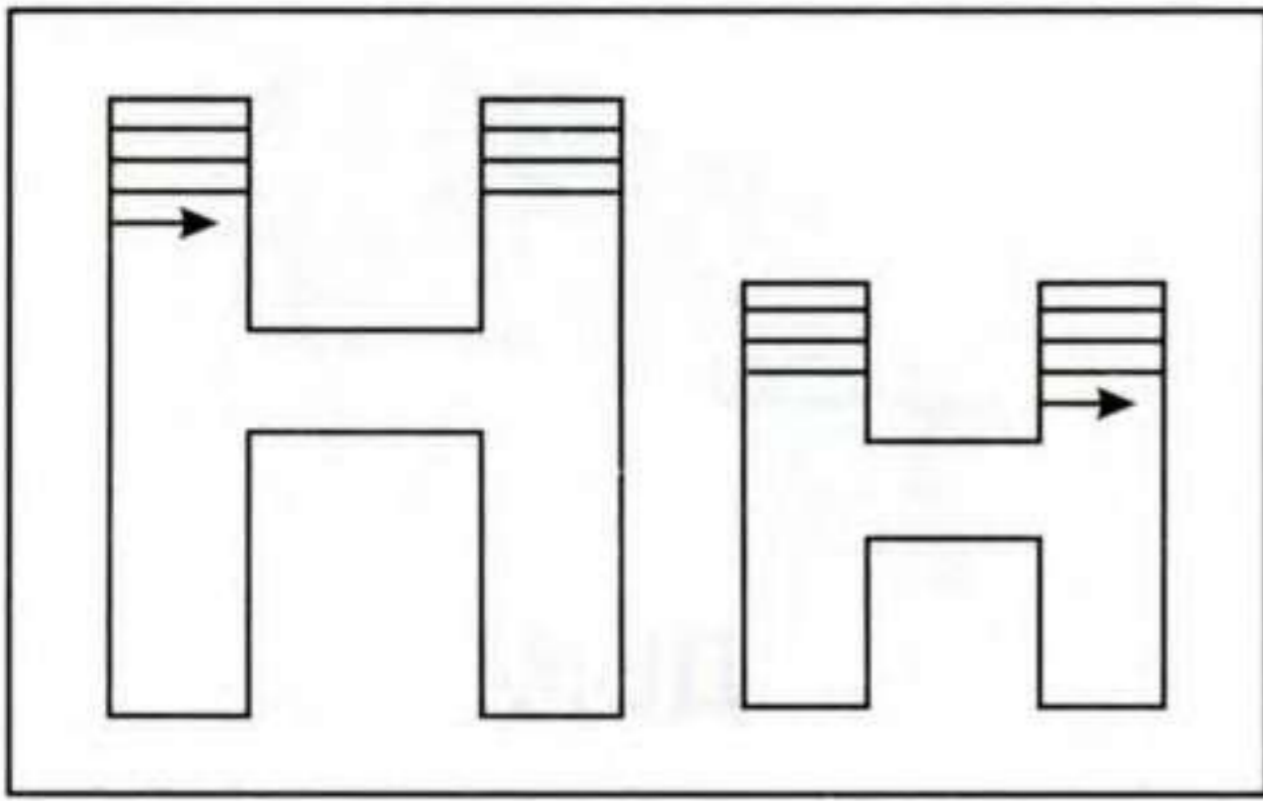

Раскрась картинку в соответствии с буквами.

А - красный
 О - жёлтый
 И - синий
 У - зеленый
 Н - коричневый

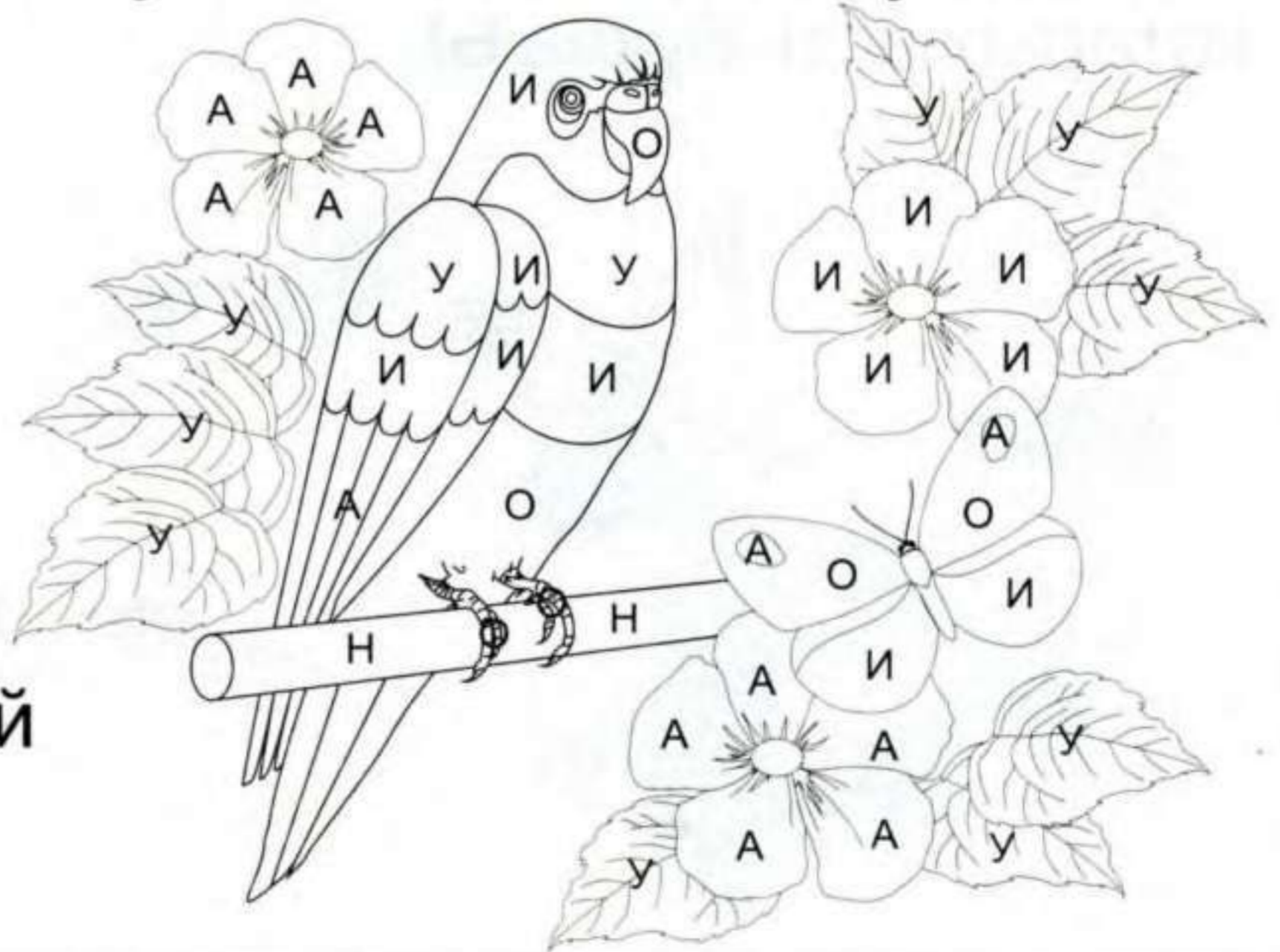

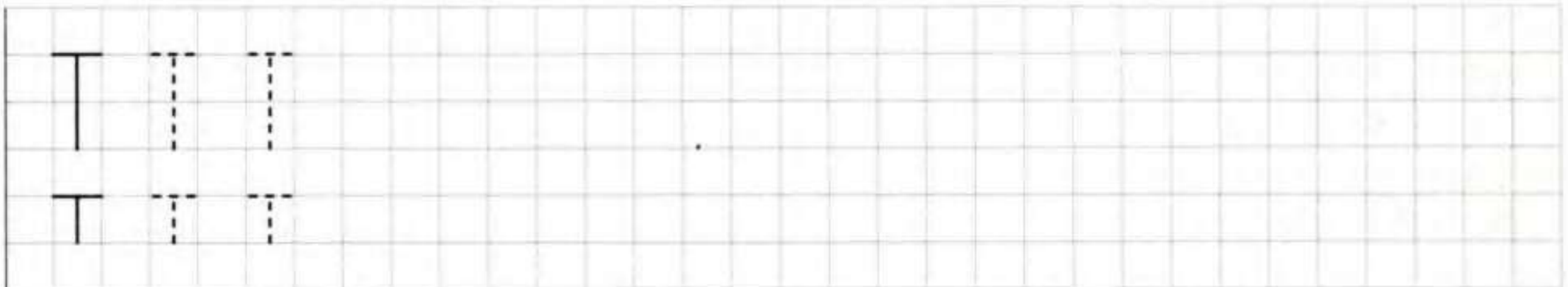
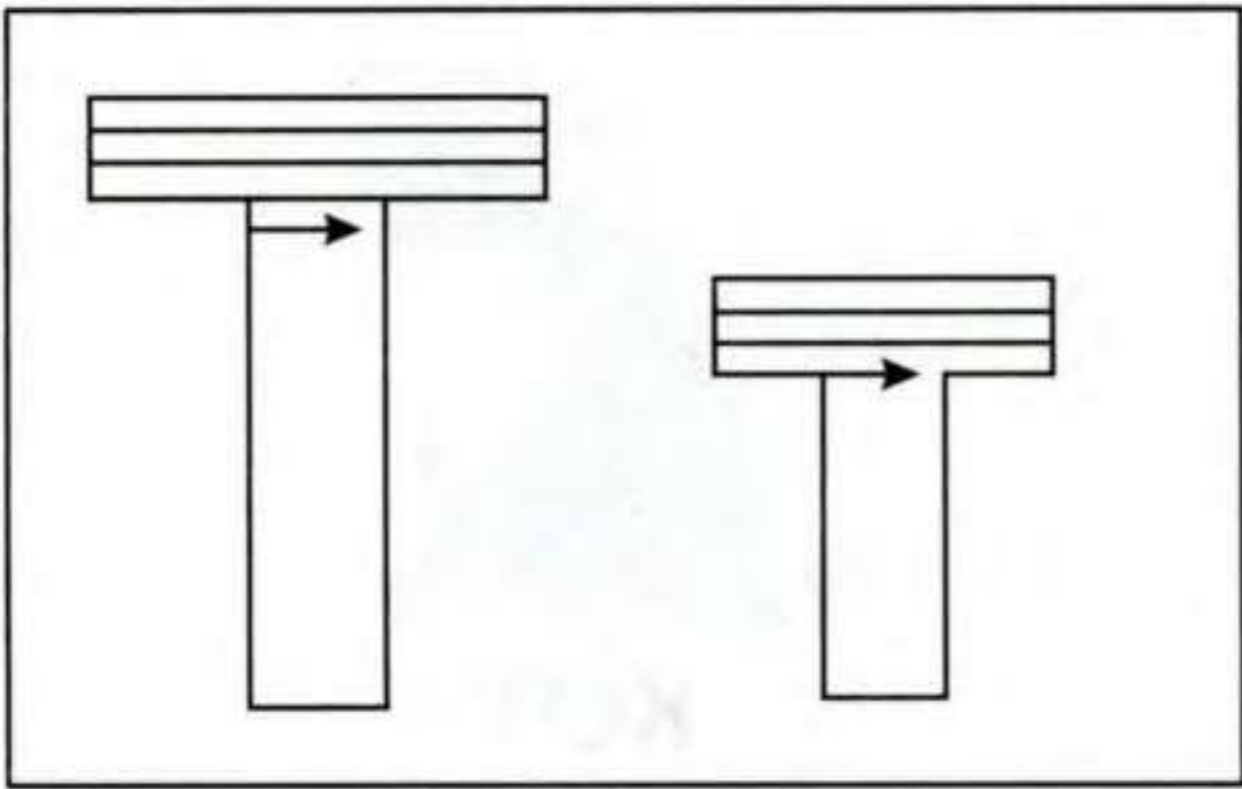

В каком названии предмета буква Т встречается в начале слова, в каком - в середине, а в каком в конце? Соедини картинку с нужной схемой.

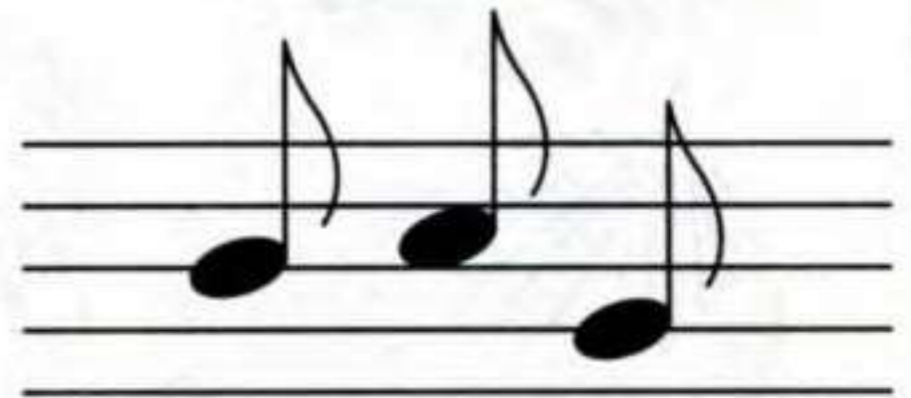
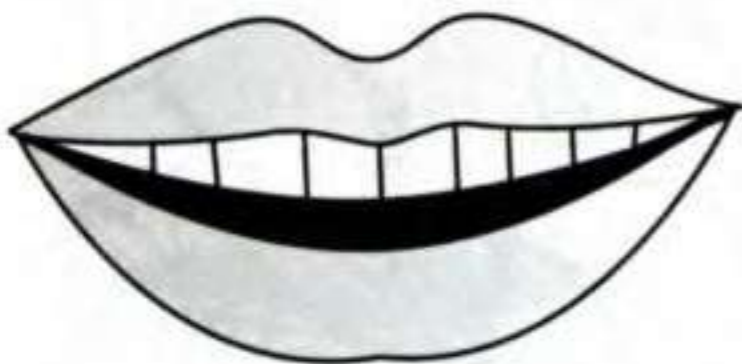
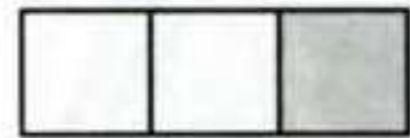
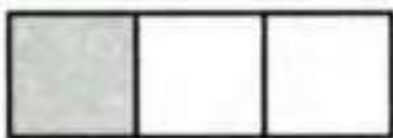

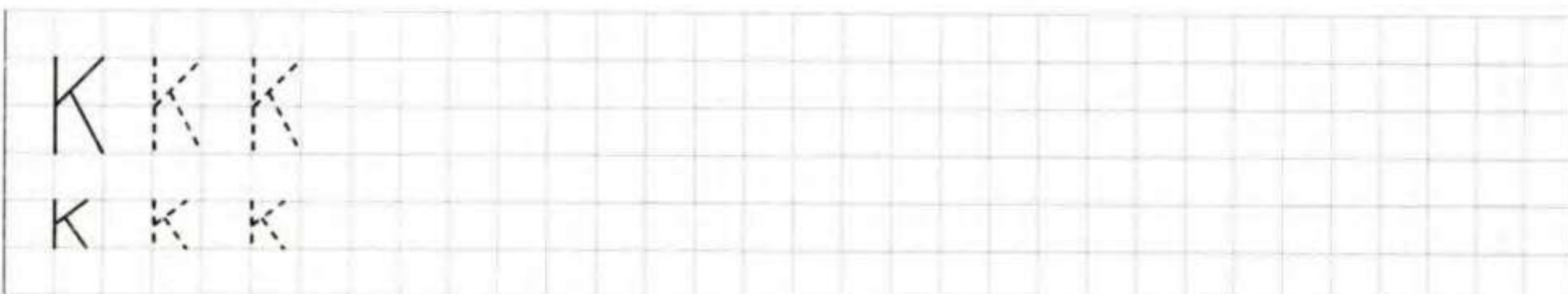
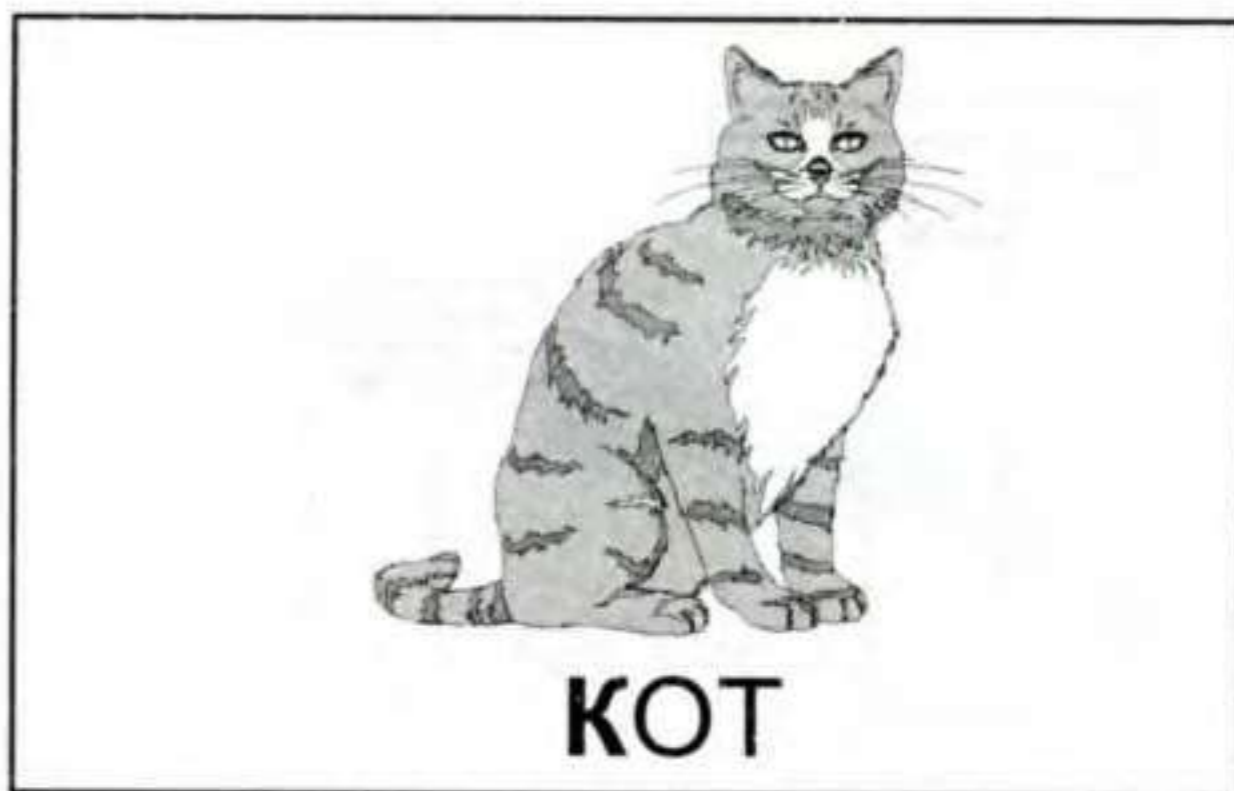
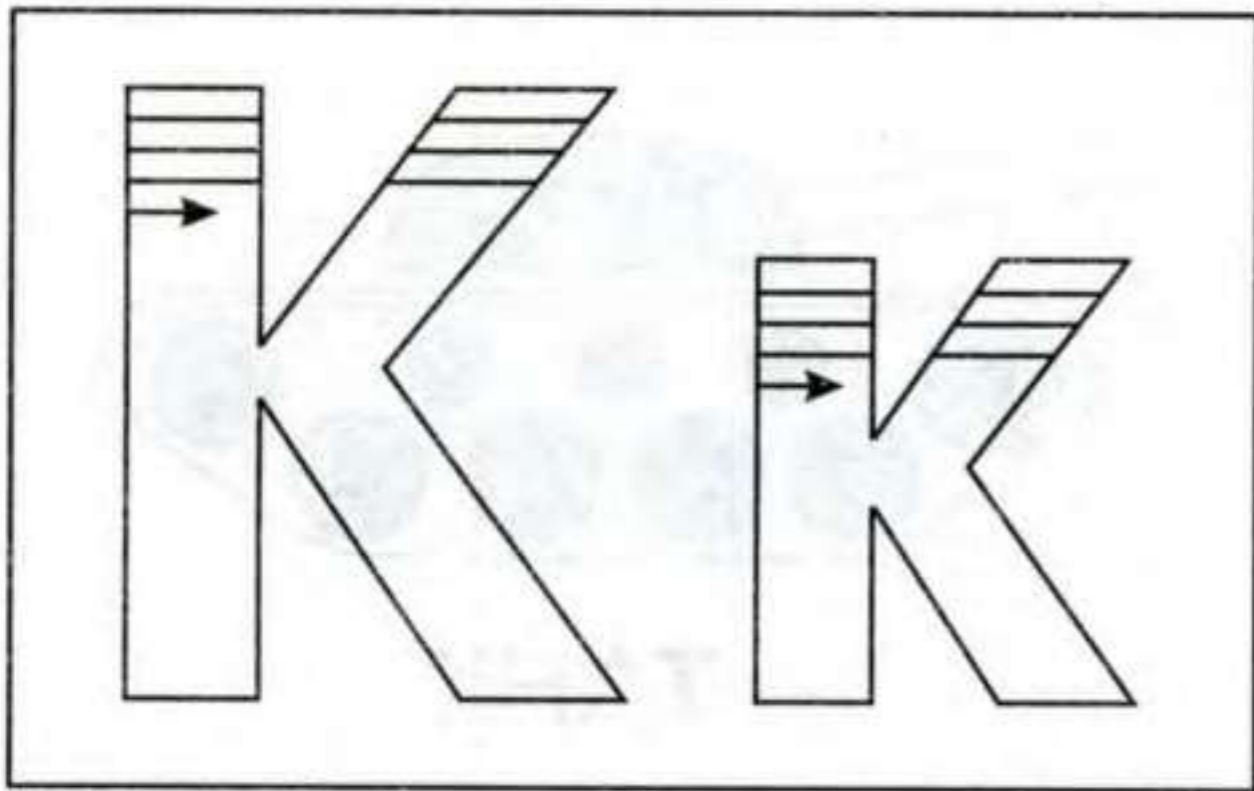

Найди и раскрась те предметы, названия которых оканчиваются на звук **К**.

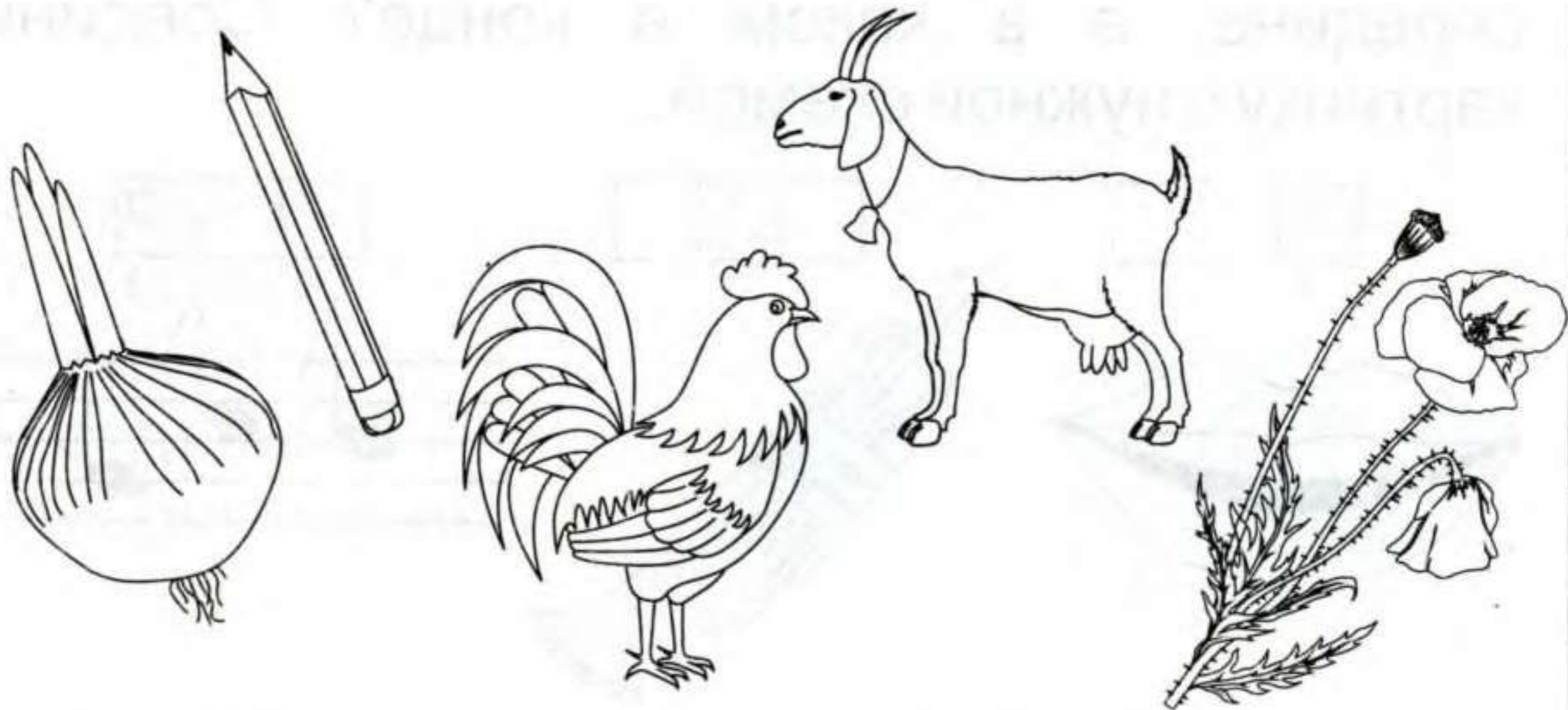

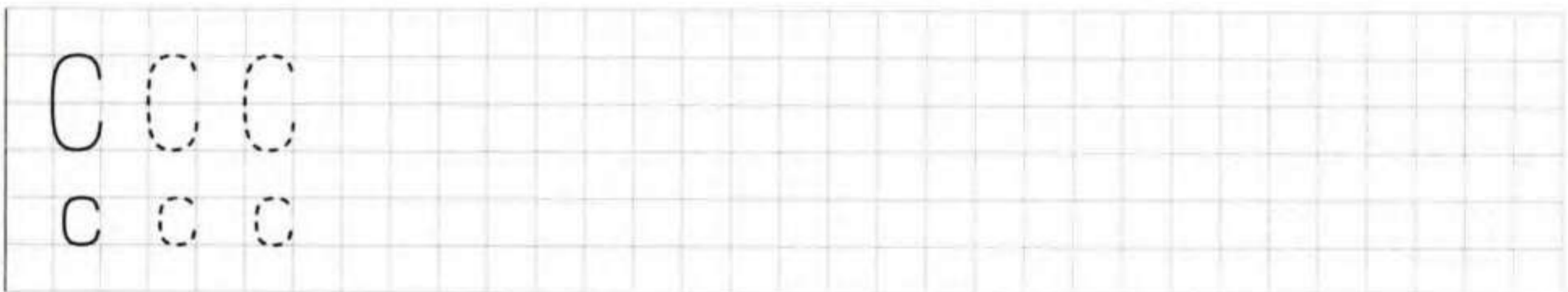
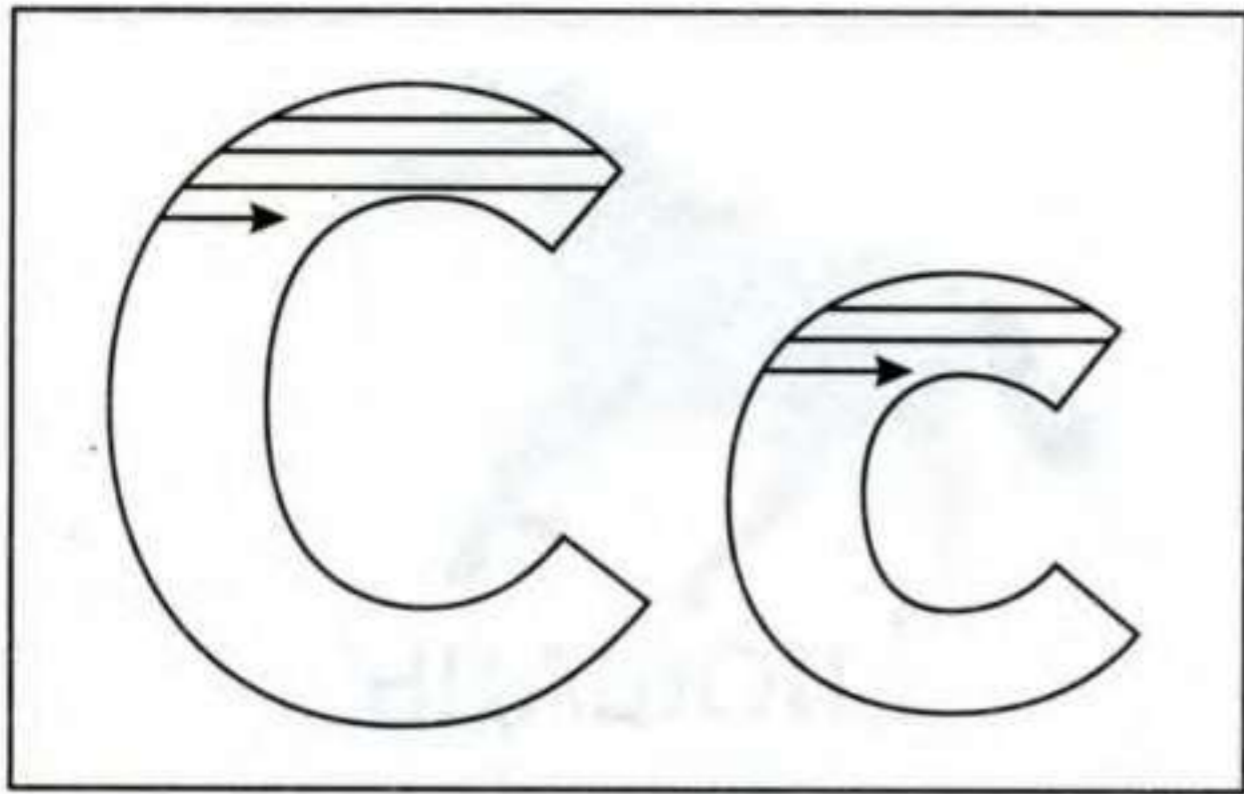

Соедини между собой предметы, названия которых начинаются на одну и ту же букву.

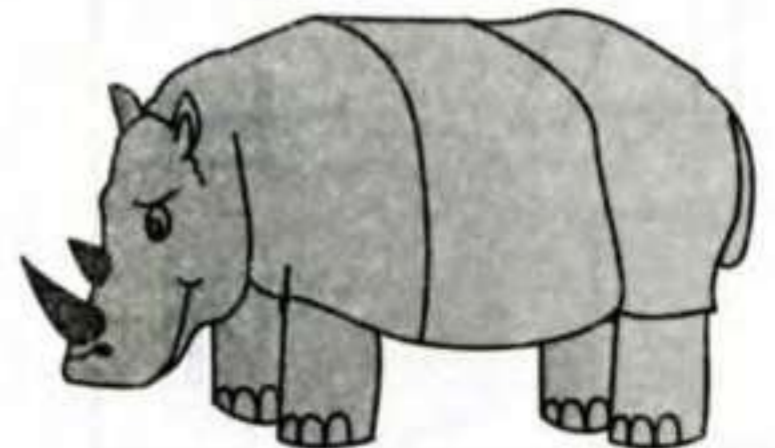
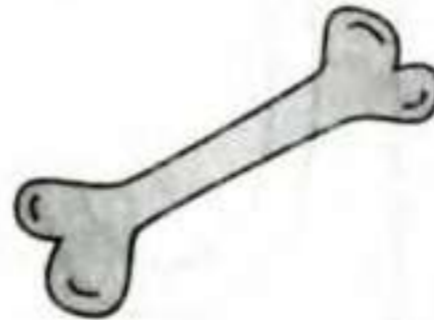
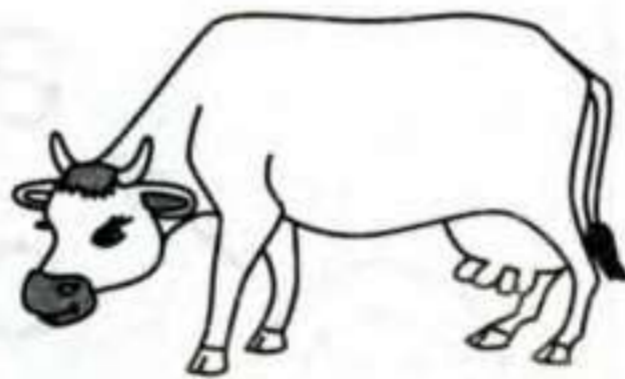

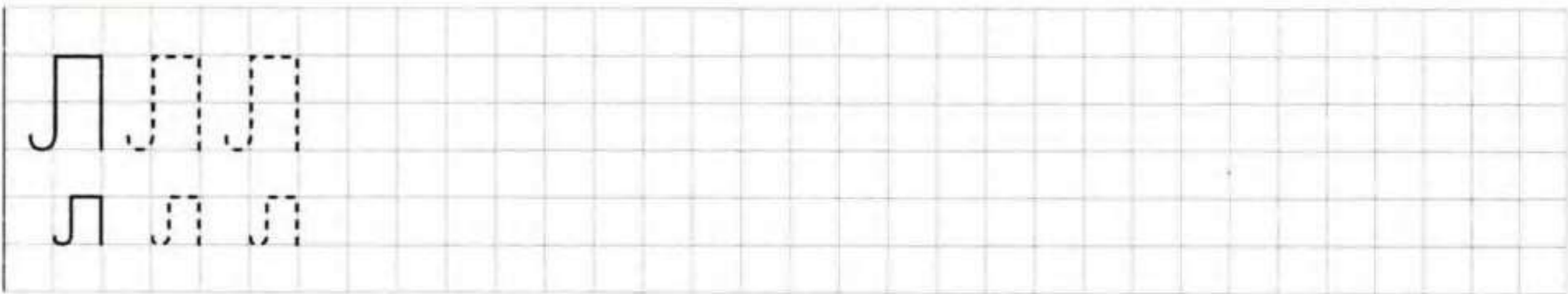
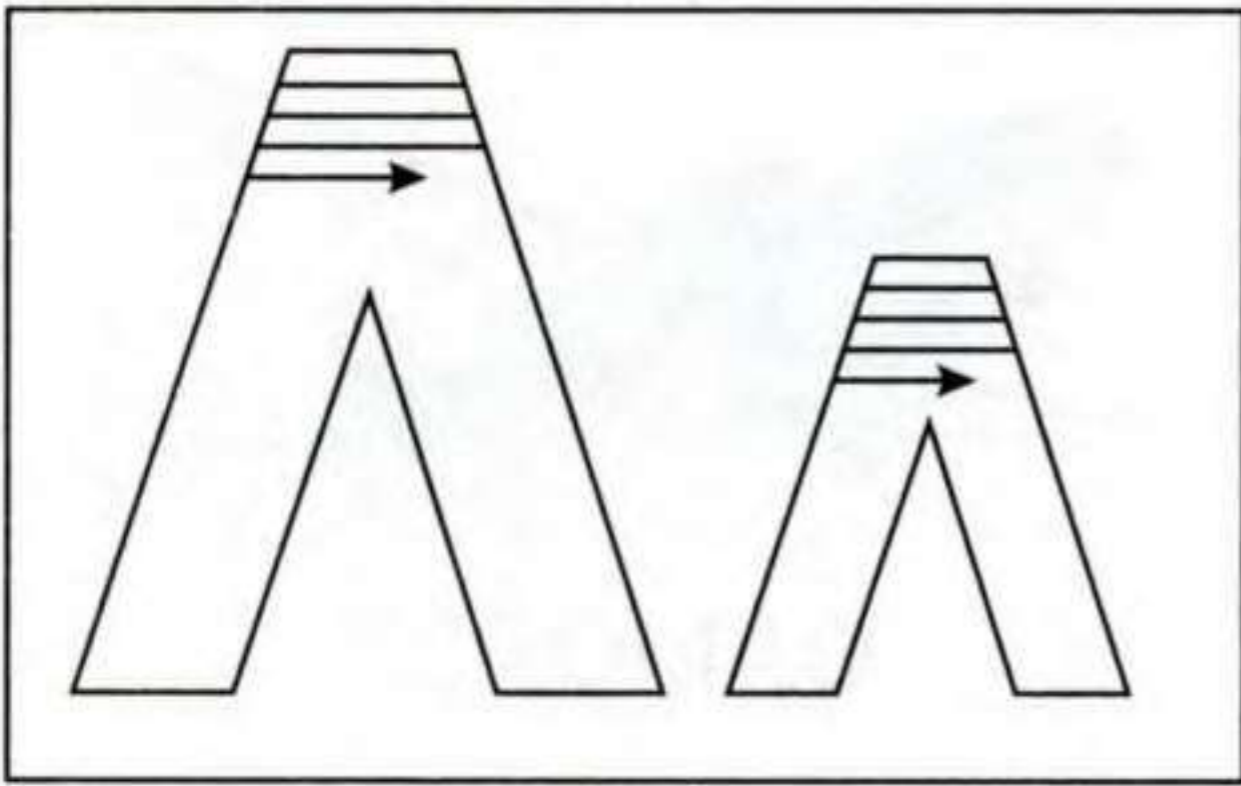



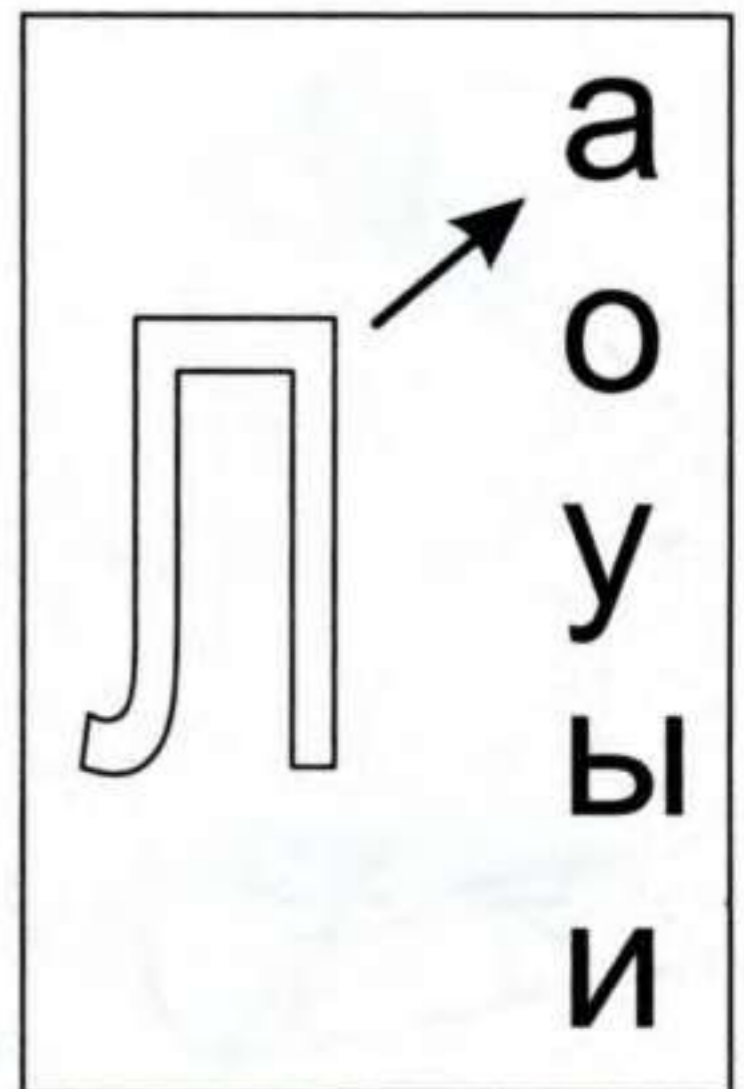
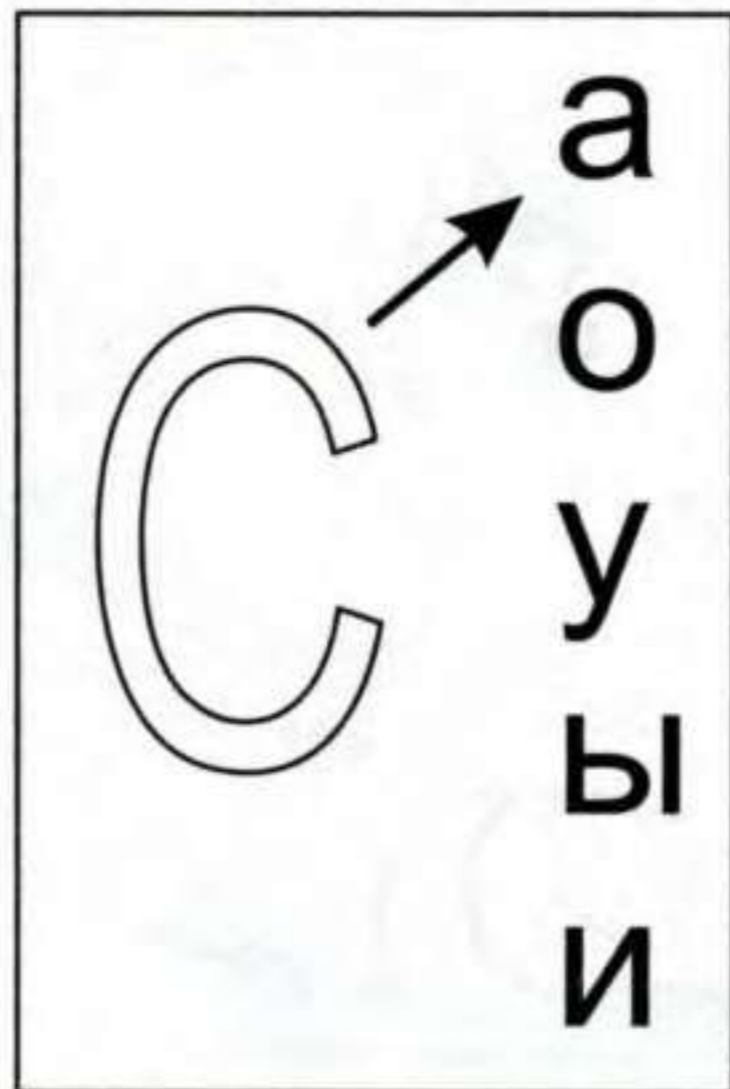
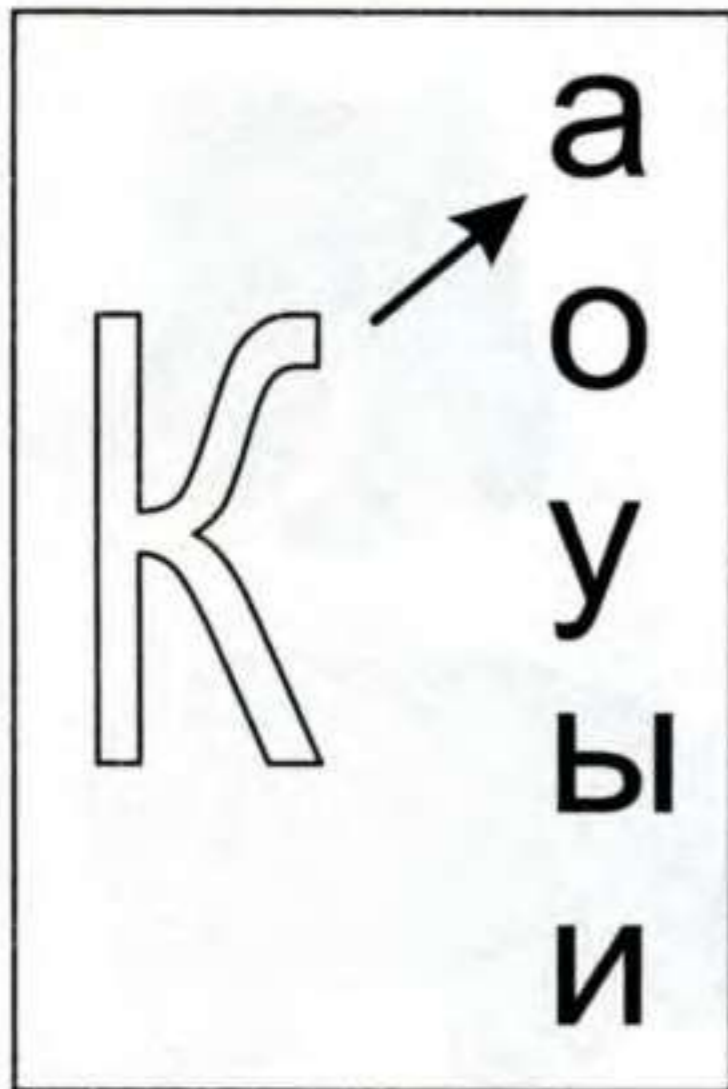

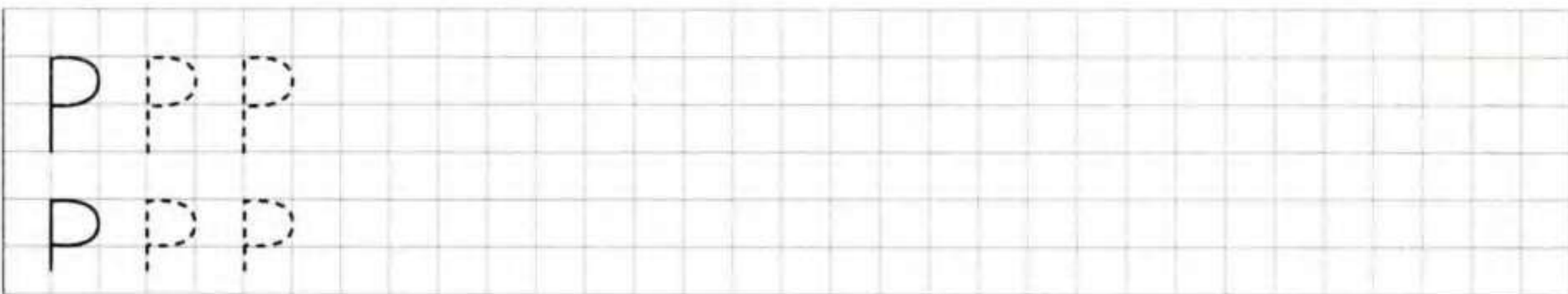
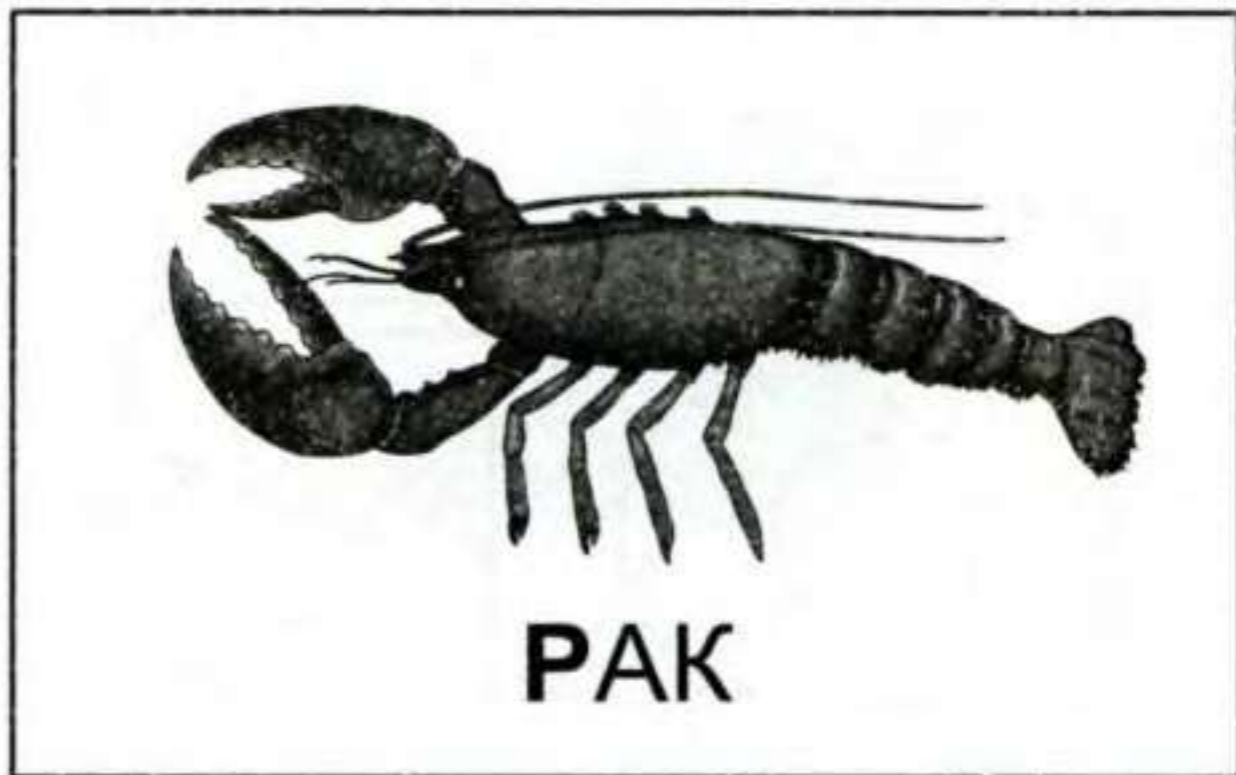
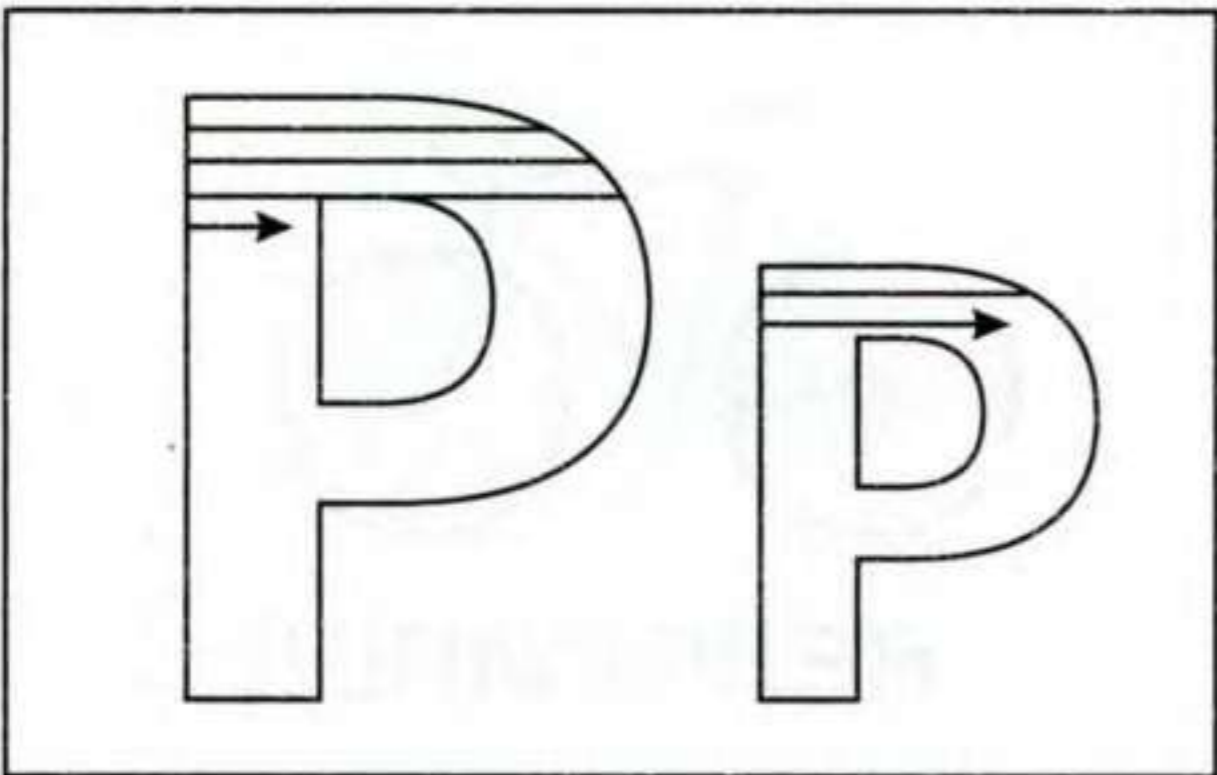



Прочитай слоги.



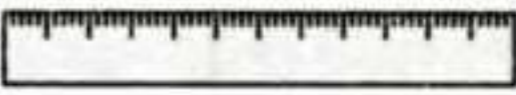

Напиши в клеточках первые буквы, с которых начинаются названия этих предметов.

	<input type="text"/>		<input type="text"/>		<input type="text"/>
	<input type="text"/>		<input type="text"/>		<input type="text"/>
	<input type="text"/>		<input type="text"/>		<input type="text"/>

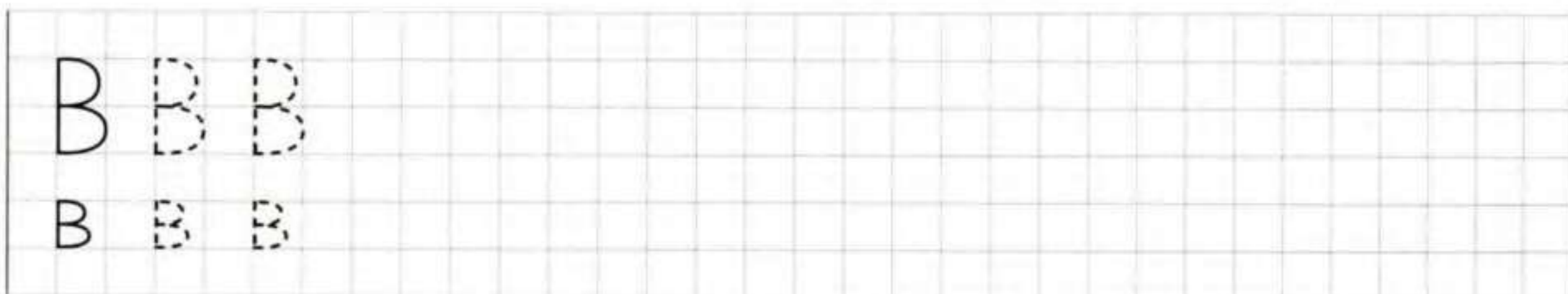
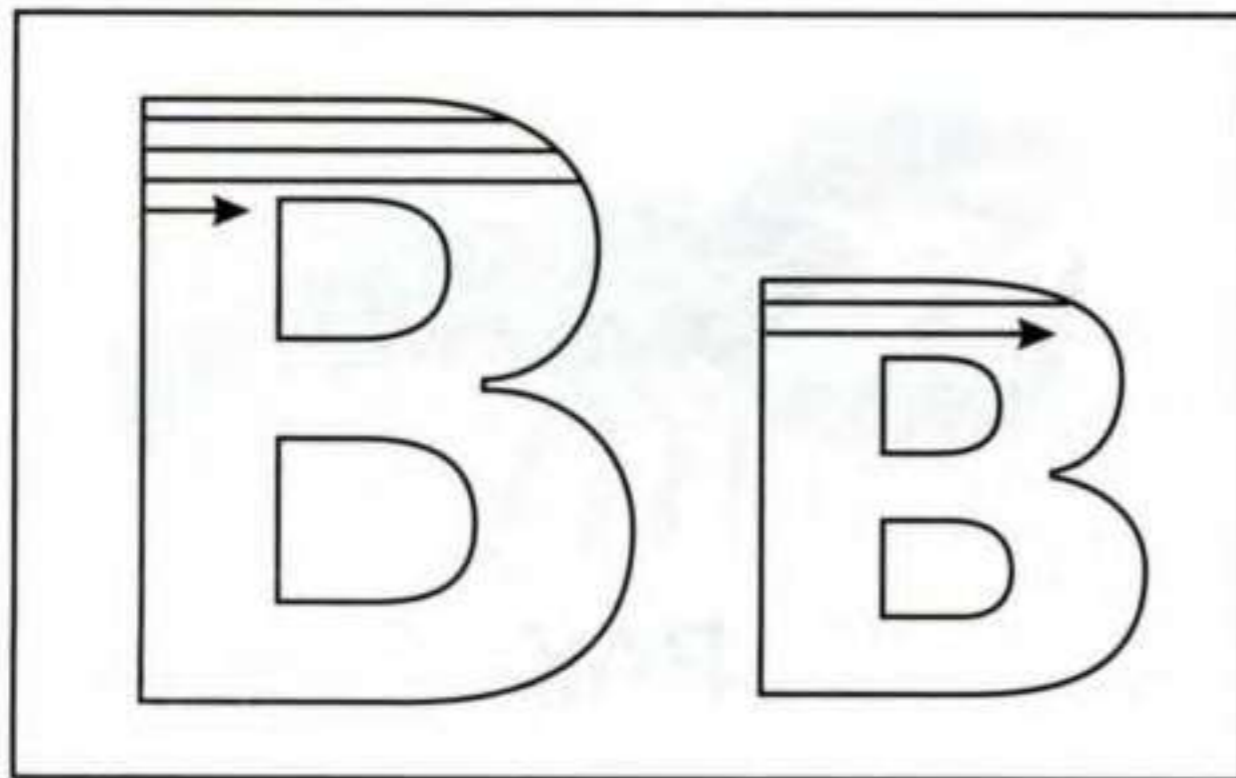

Составь слоги, напиши их в клеточках и прочитай.

	Н	Т	К	С	Л	Р	В
а	на						
о	но						
у	ну						
и	ни						

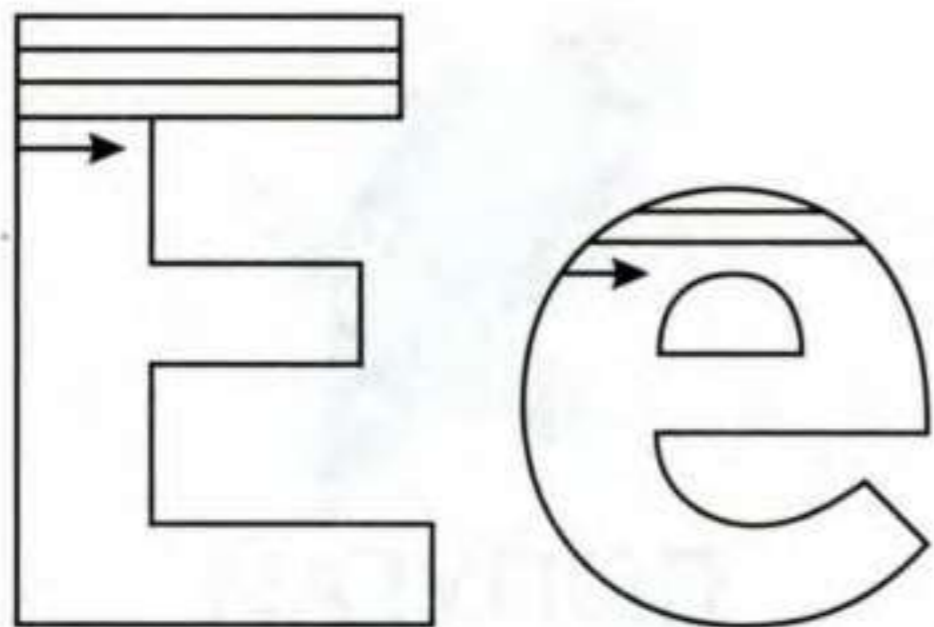

ЕЛИ

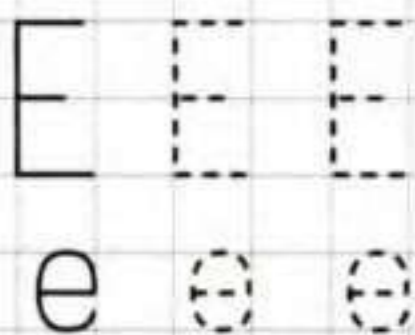

Соедини каждую картинку со слогом, с которого начинается её название.

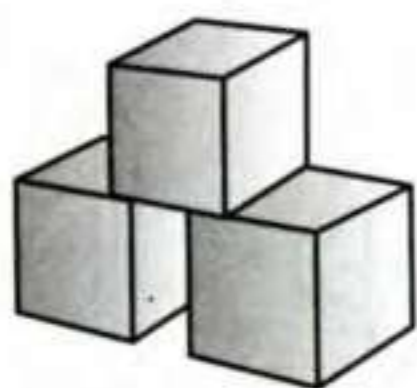

ва ку

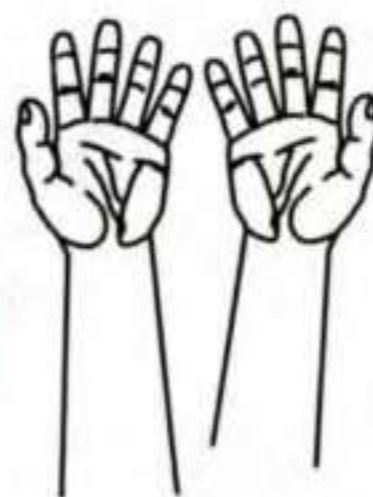

ру ло

ту са



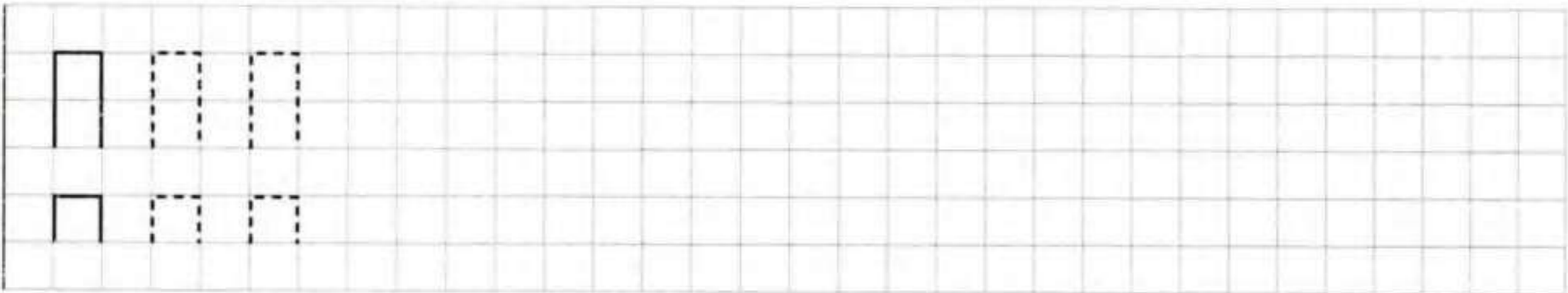
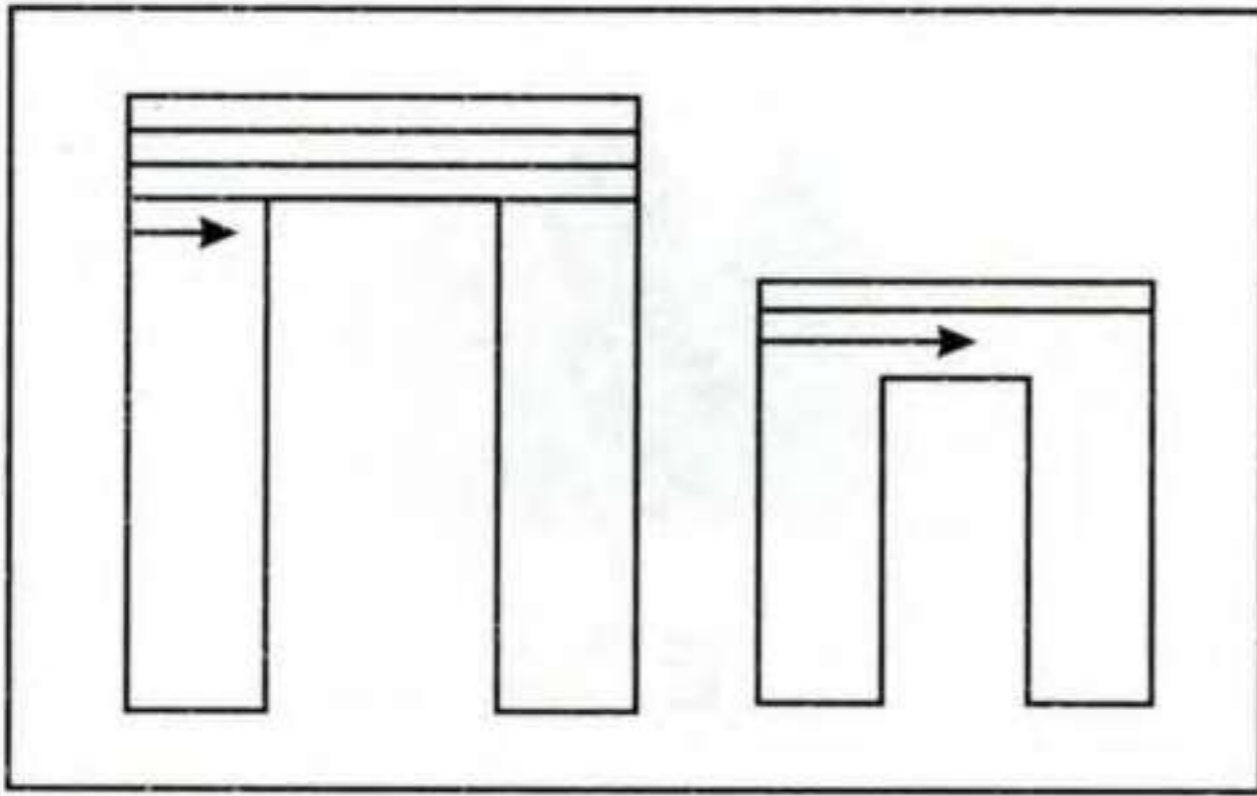

Раскрась те предметы, в названиях которых
есть буква **П**.

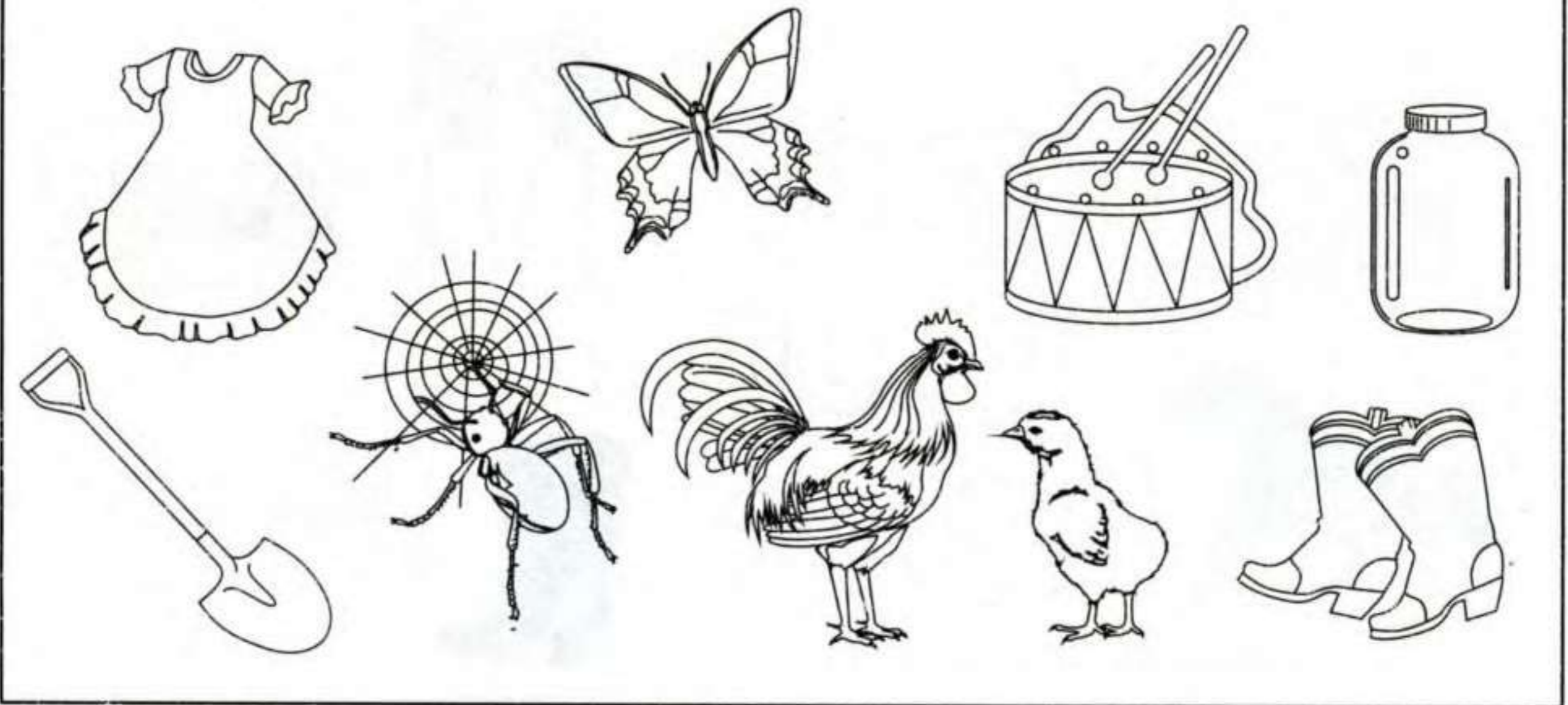

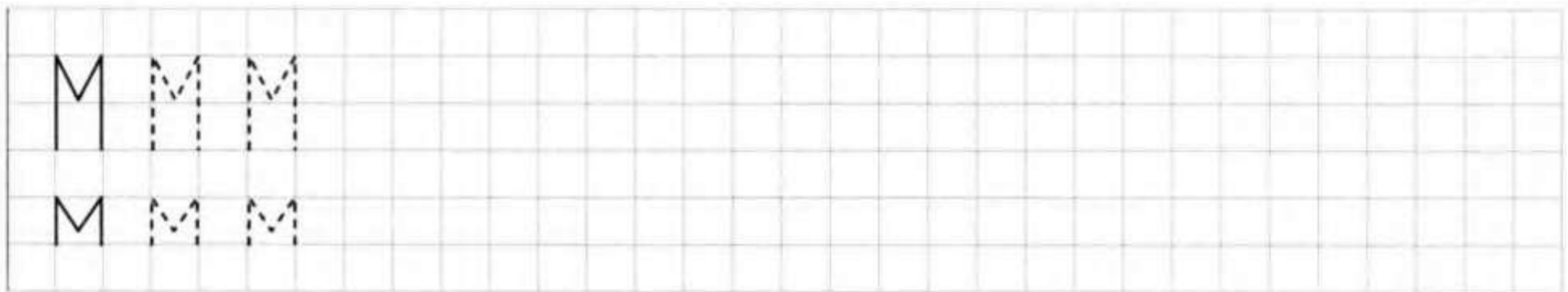
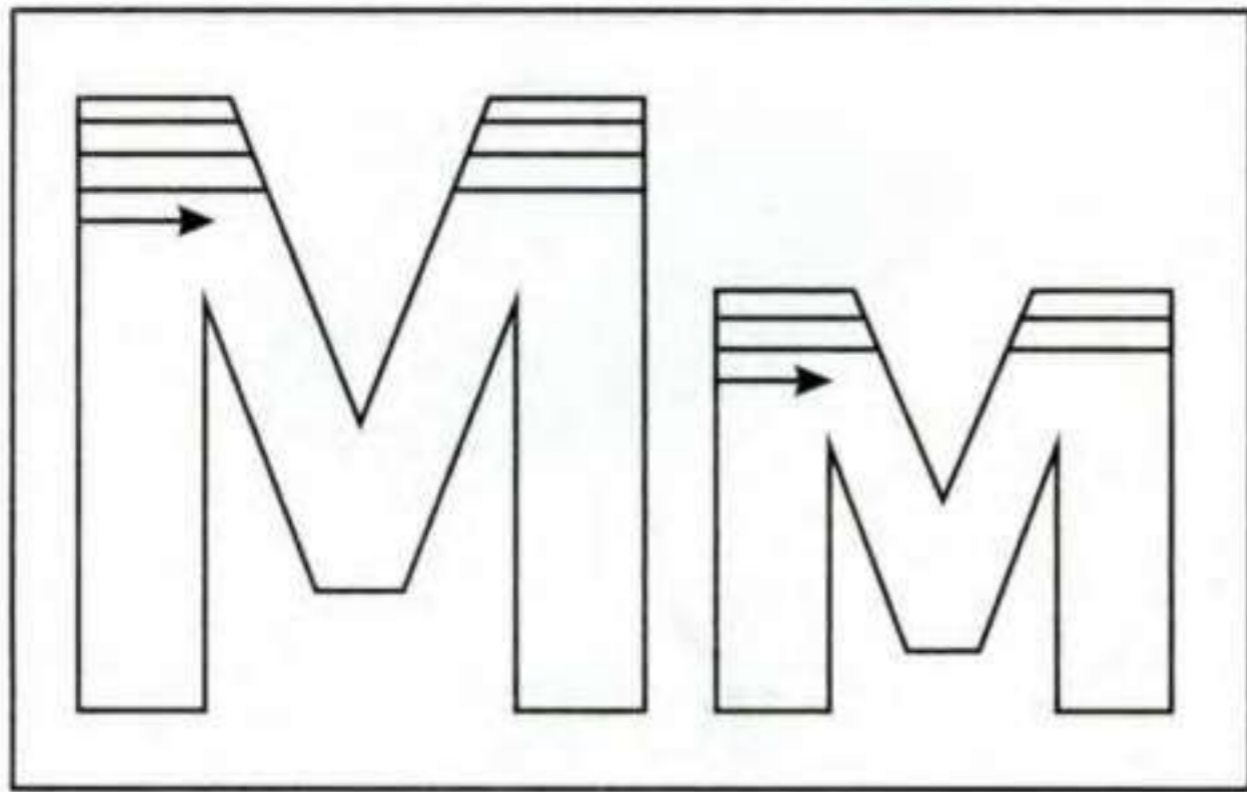

Найди каждой букве пару. Соедини большие буквы с маленькими.

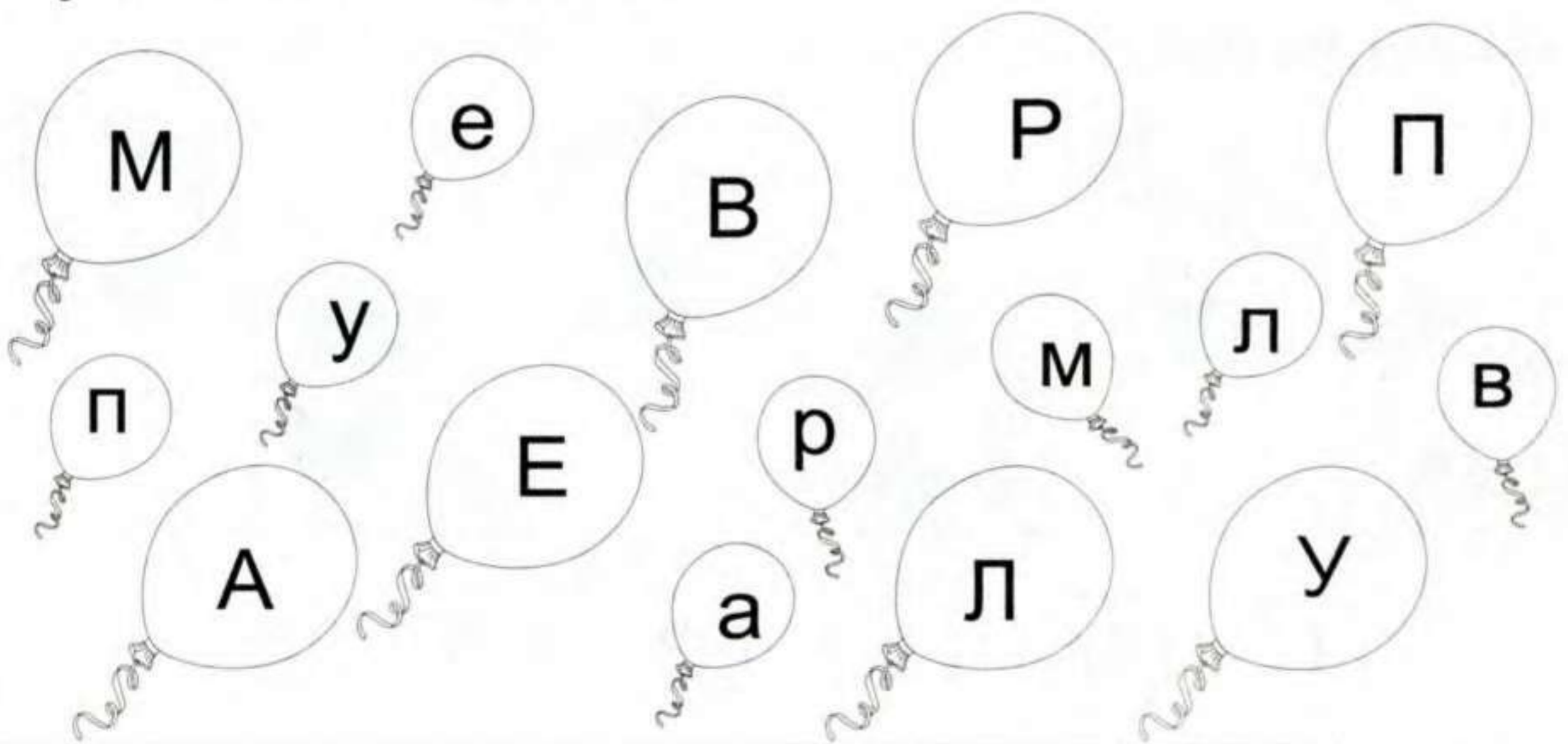

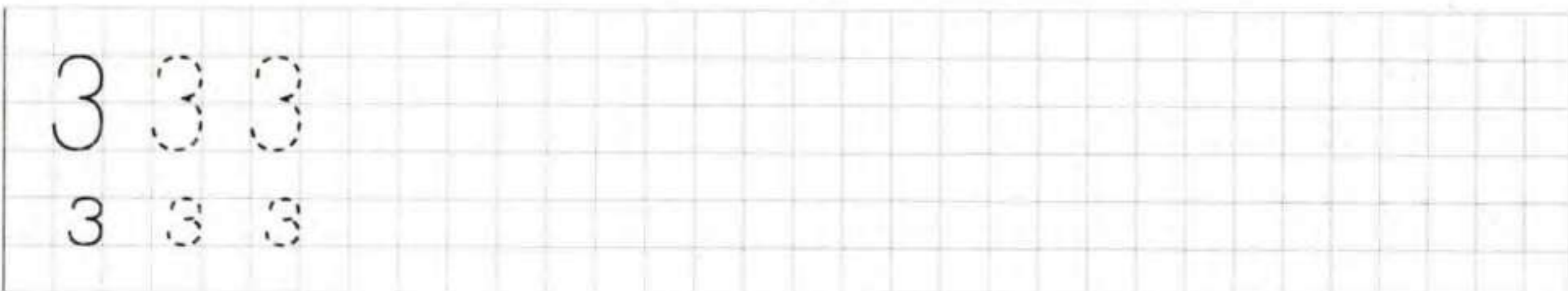
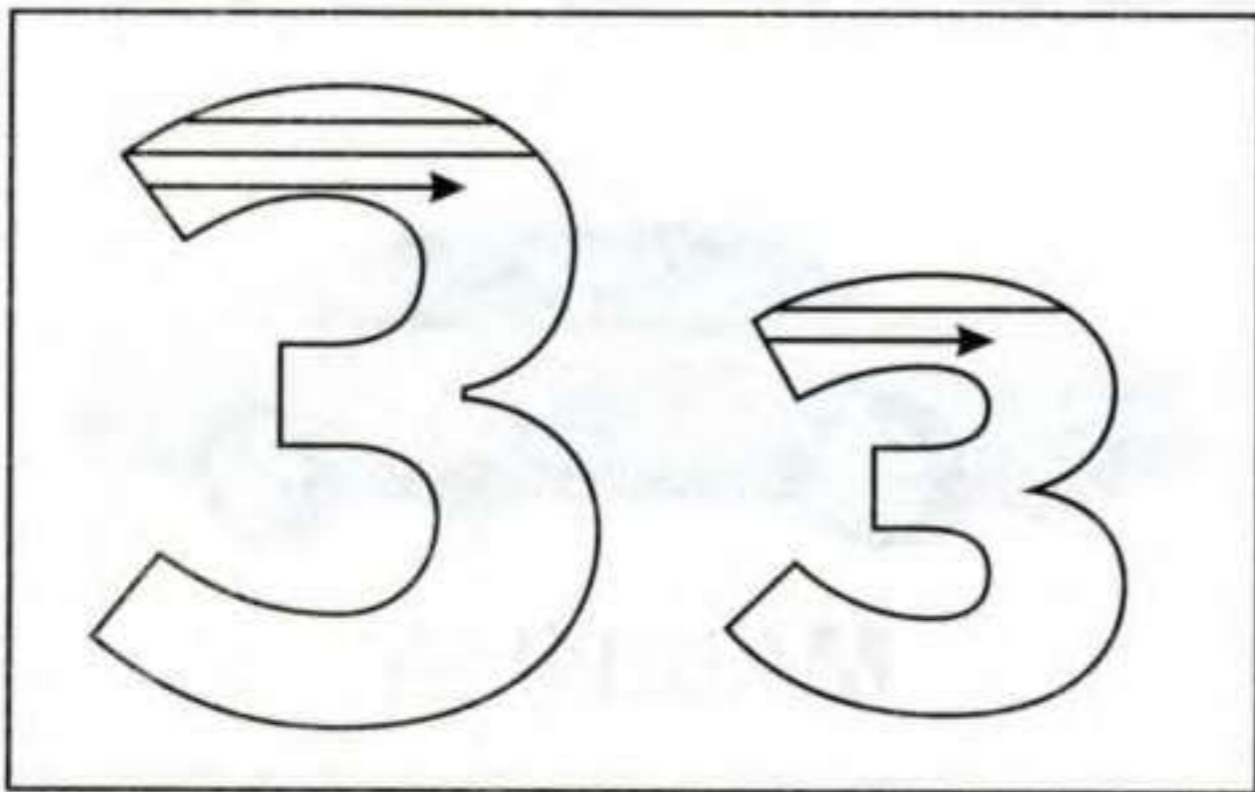

Назови картинку в каждом квадрате.
Соедини их с той буквой, с которой они начинаются.

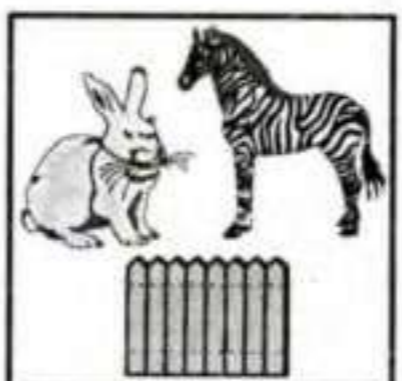
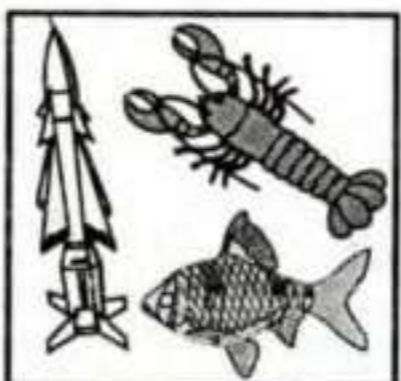
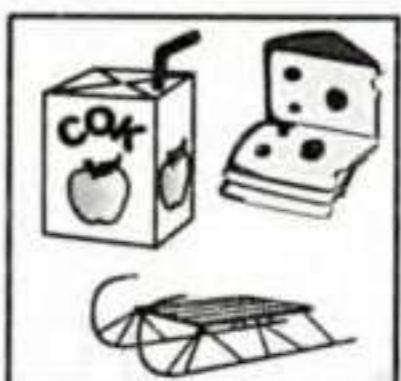

С

М

З

В

П

Р

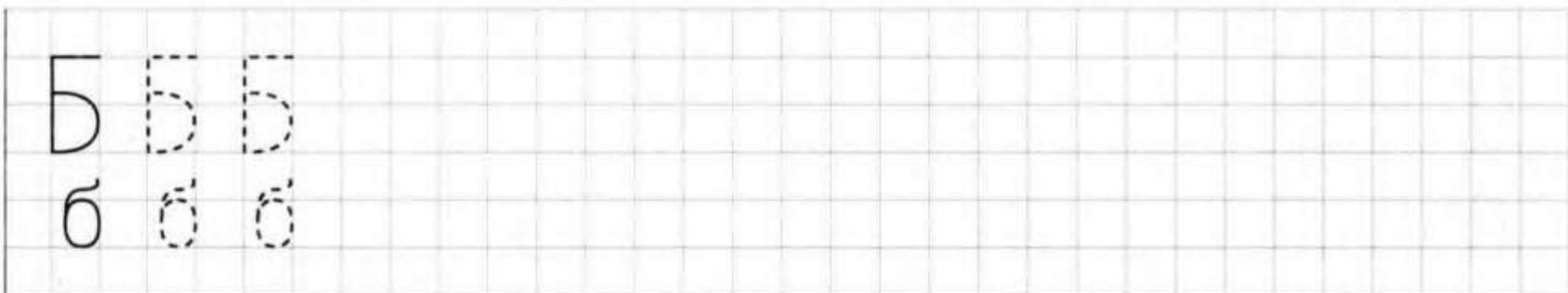
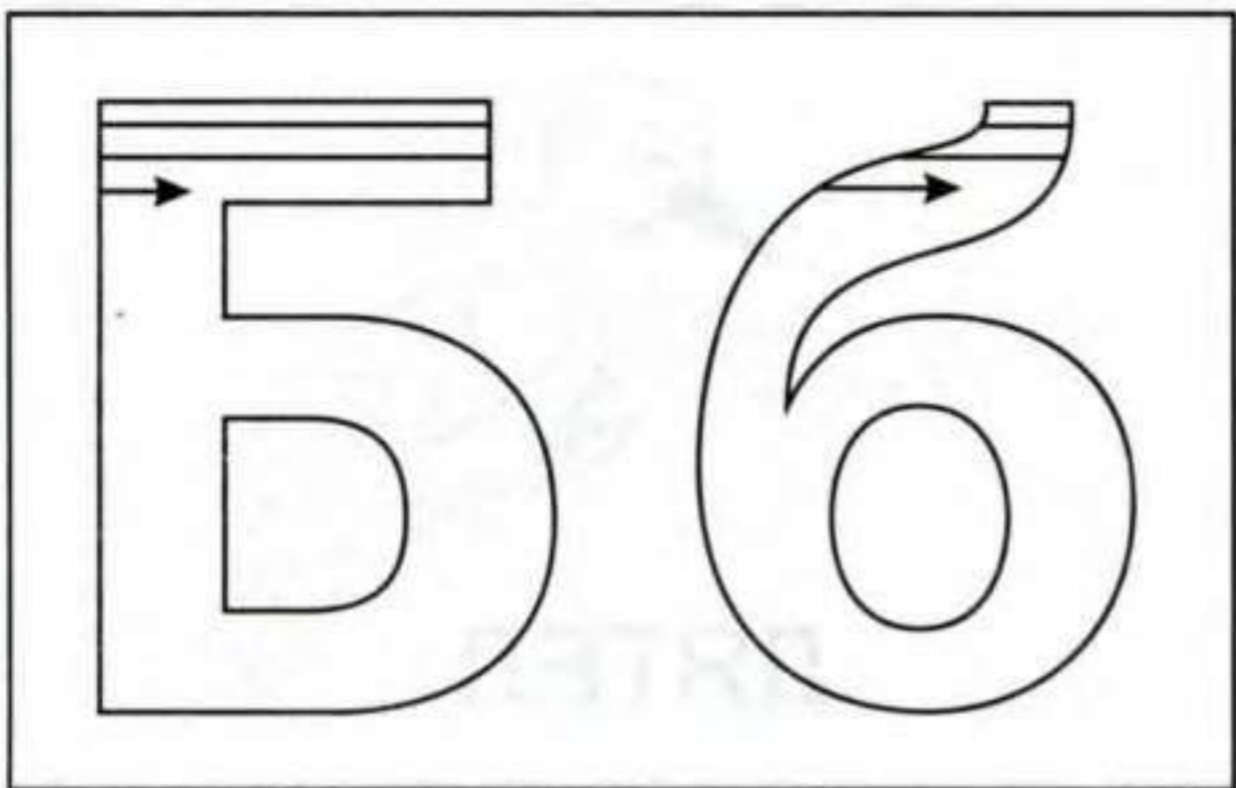

Прочитай слоги: соедини согласную букву в середине звездочки с гласными в её лучах. Придумай слова, которые начинаются на эти слоги.

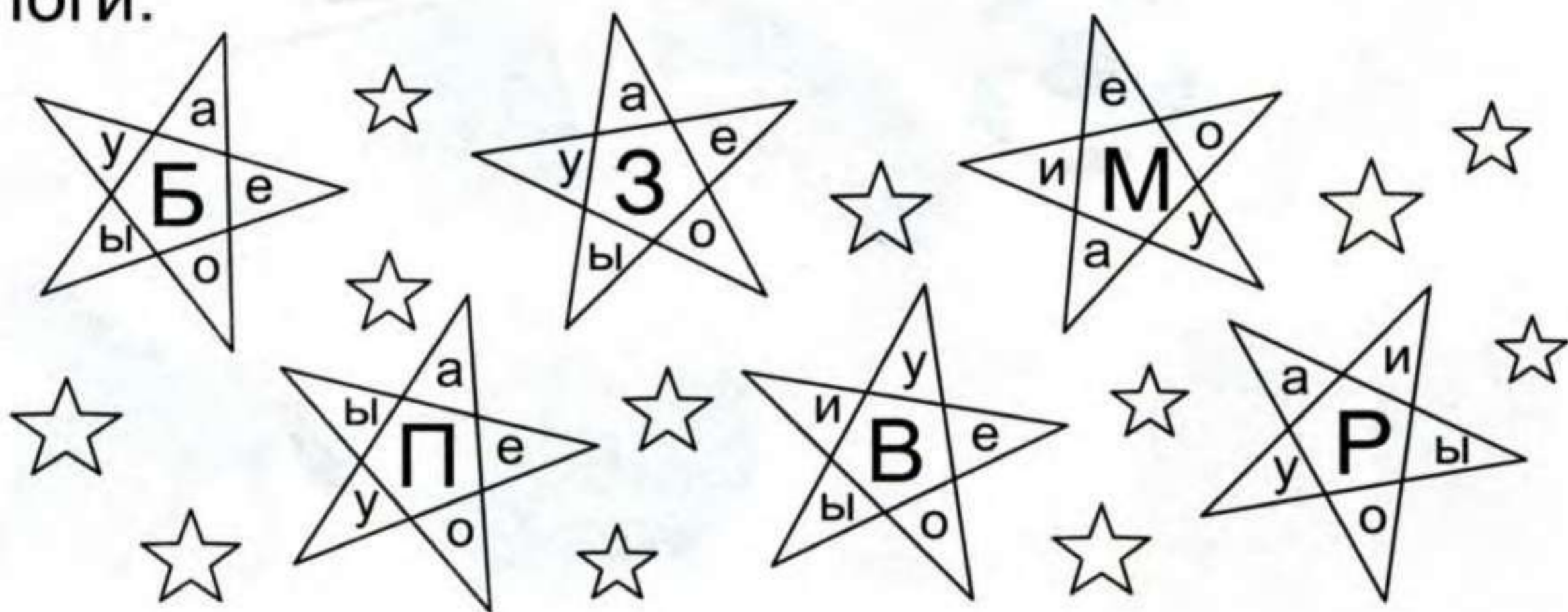

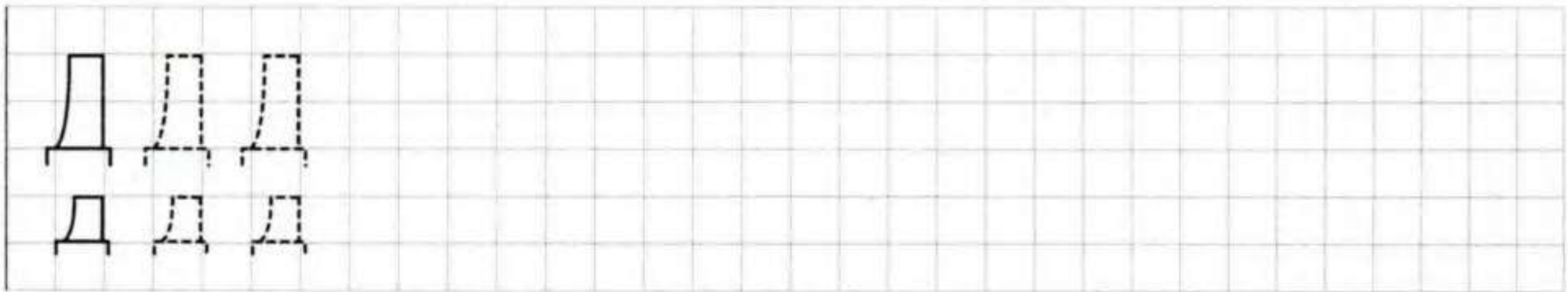
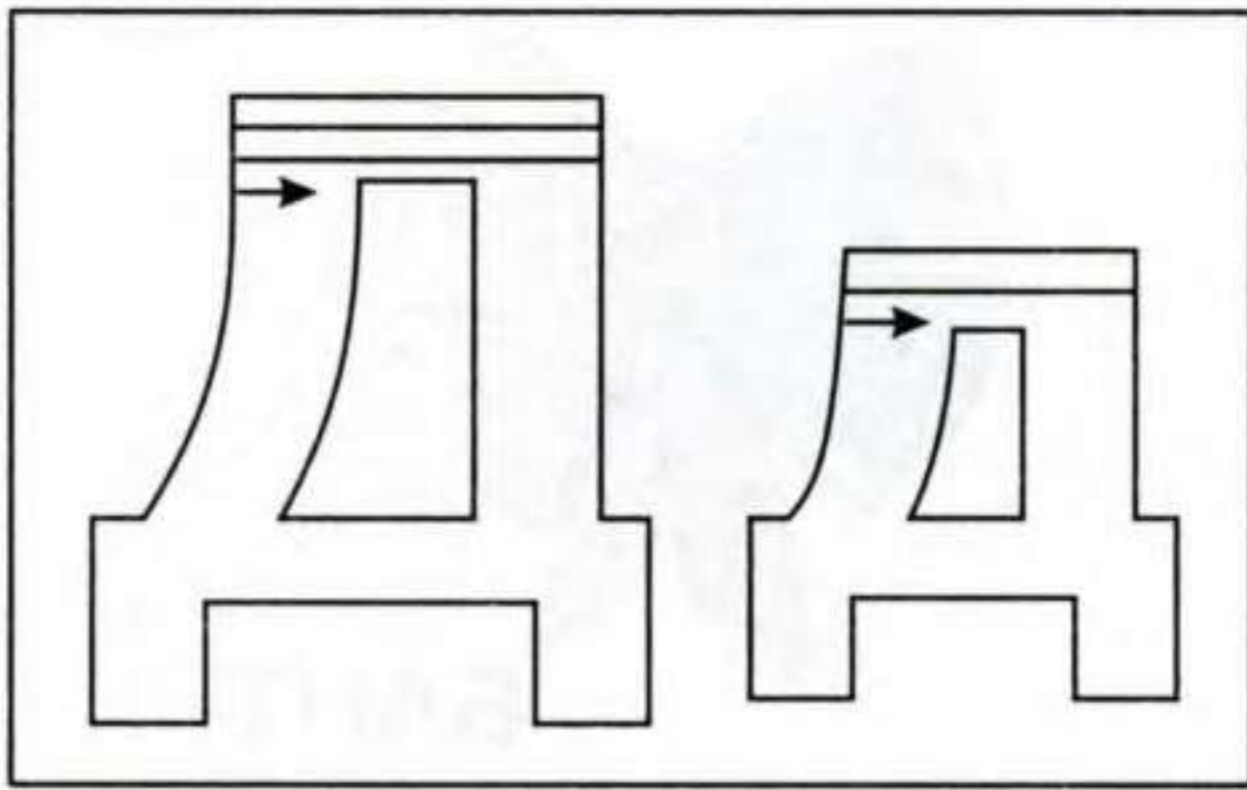

Соедини предметы, названия которых начинаются на одну и ту же букву.

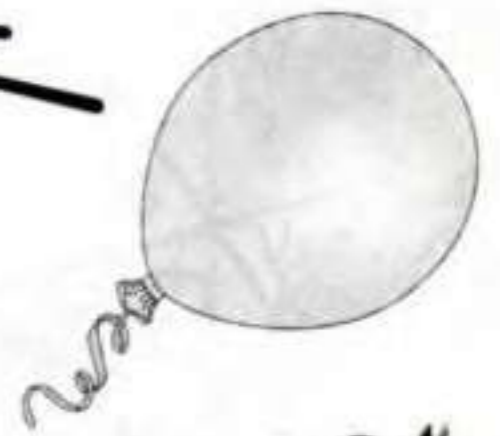

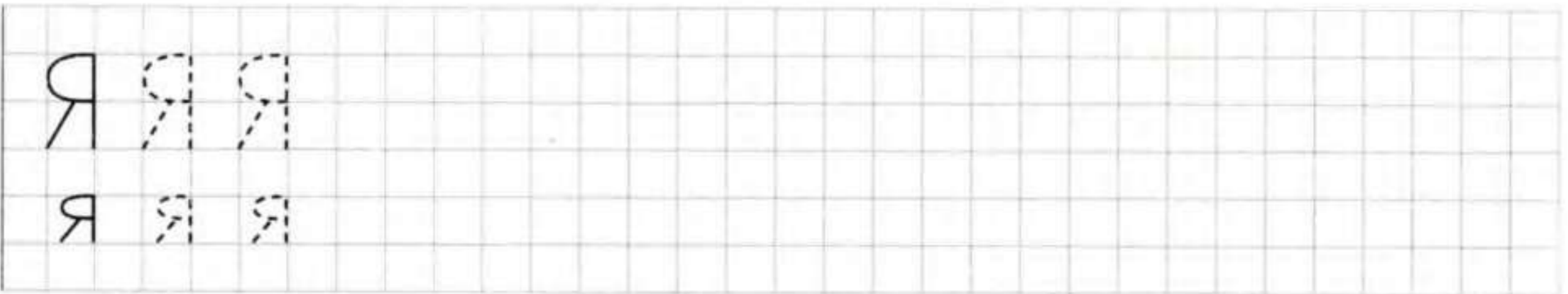
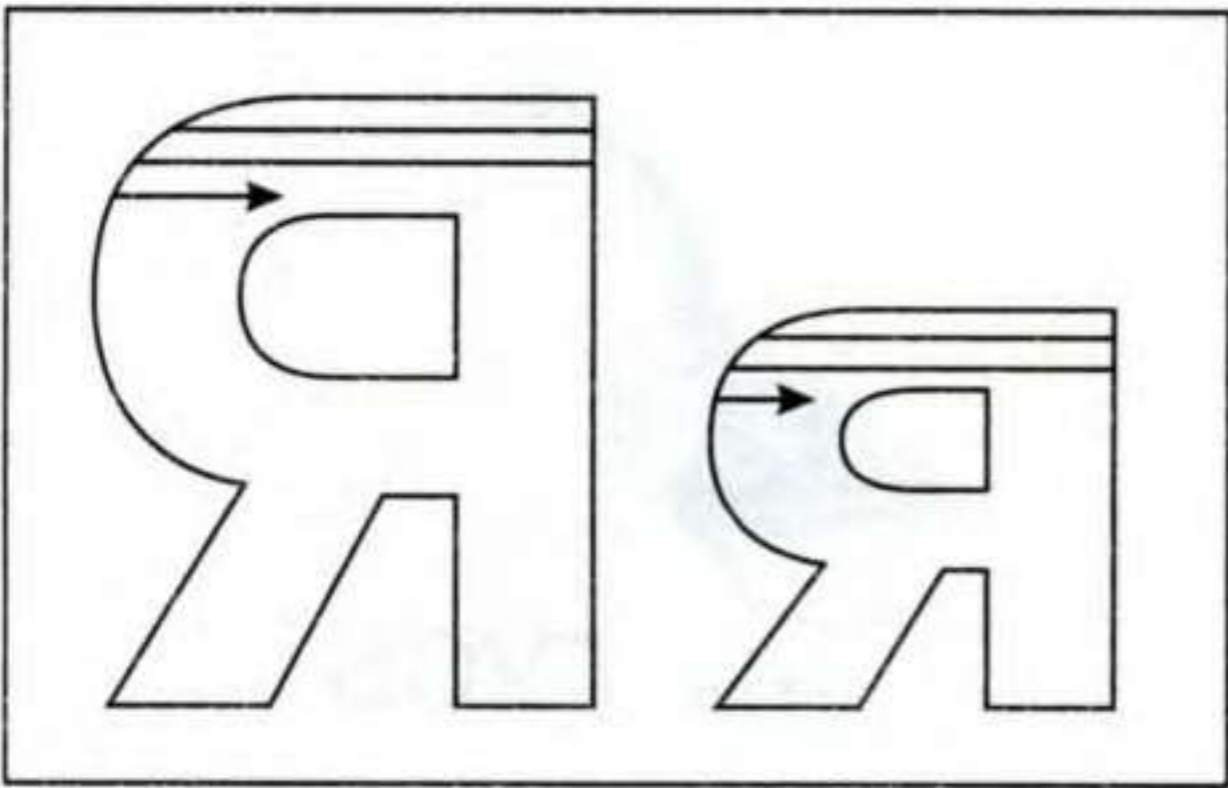

Соедини линиями слова, которые оканчиваются на одну и ту же букву.

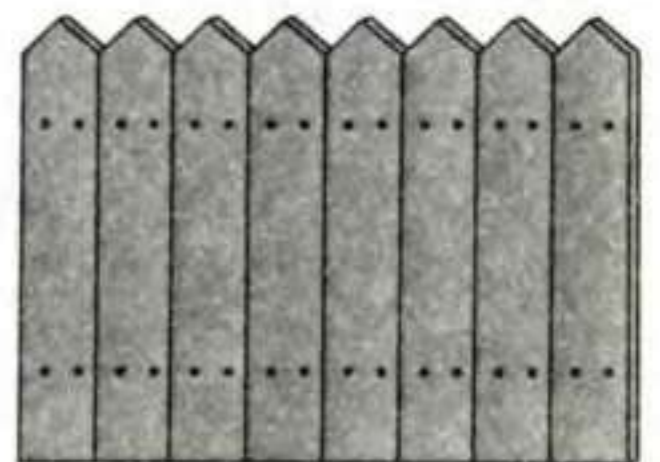

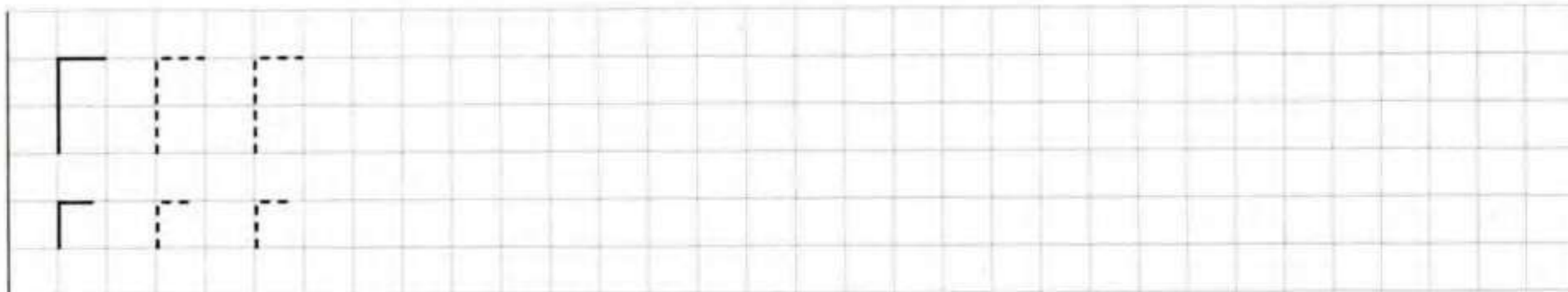
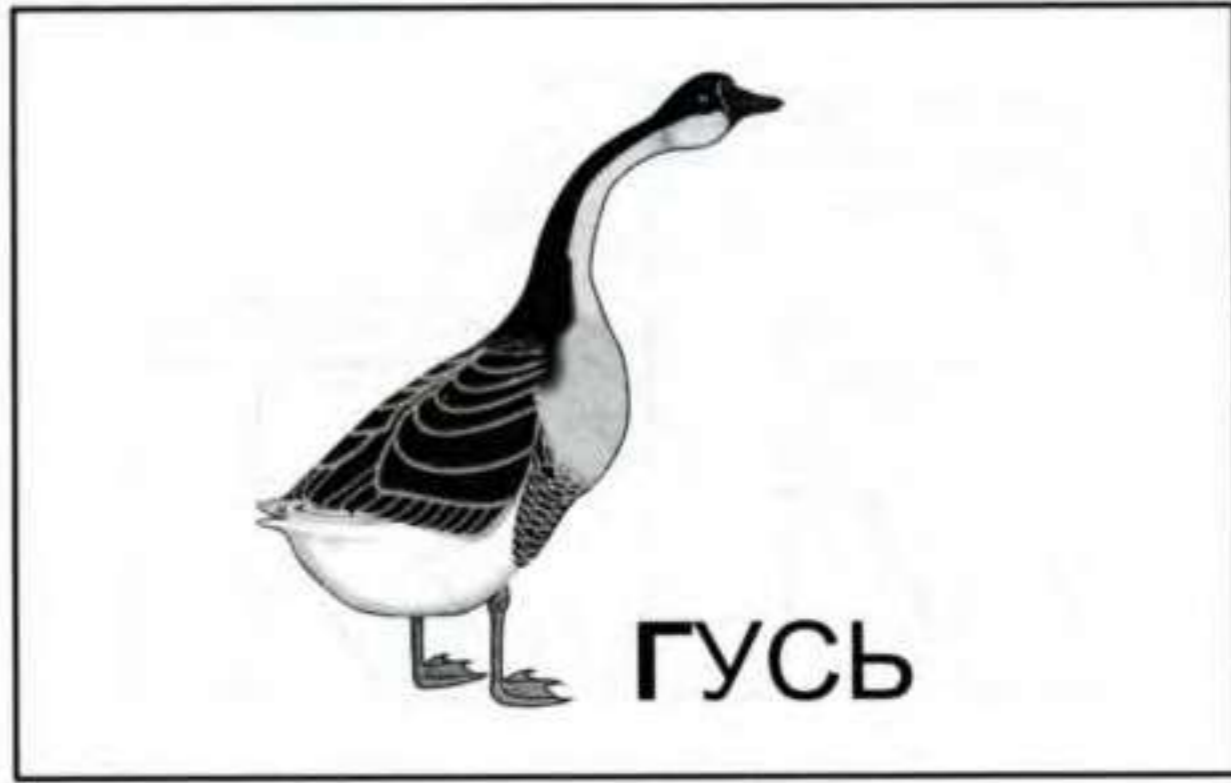
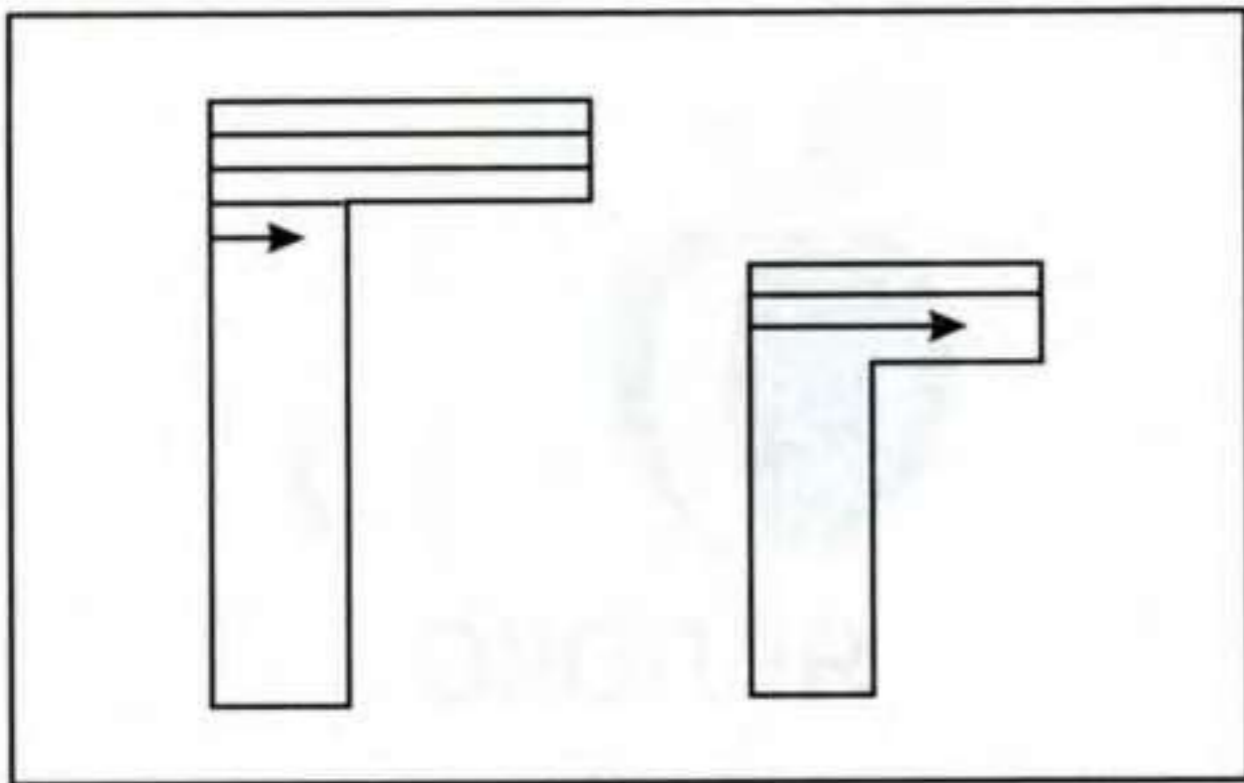

Найди буквы, которые спрятались на картинках.

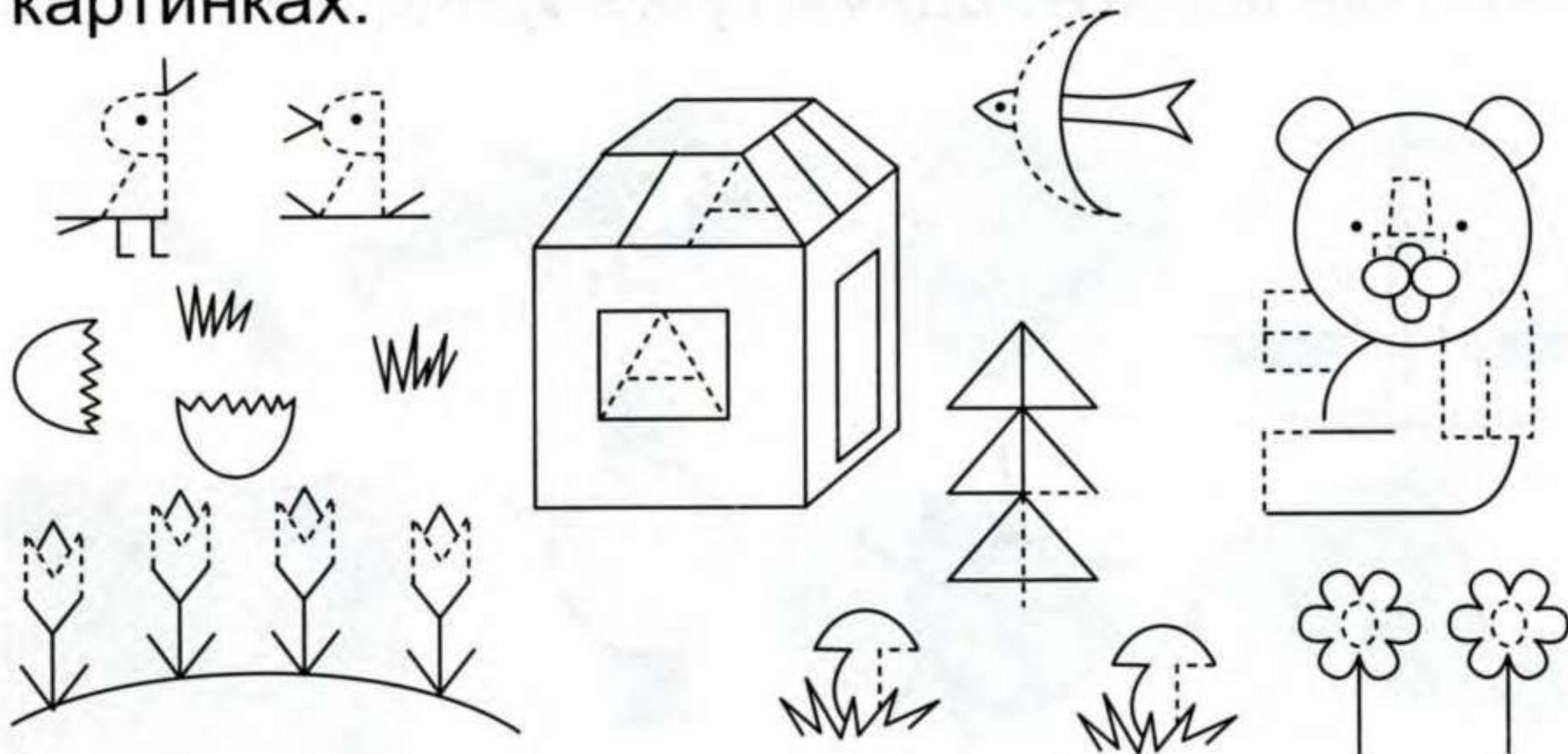

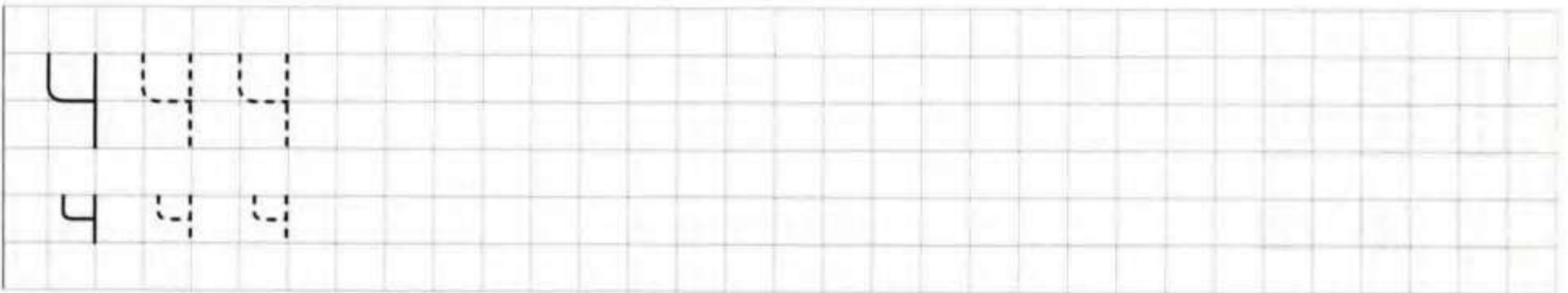
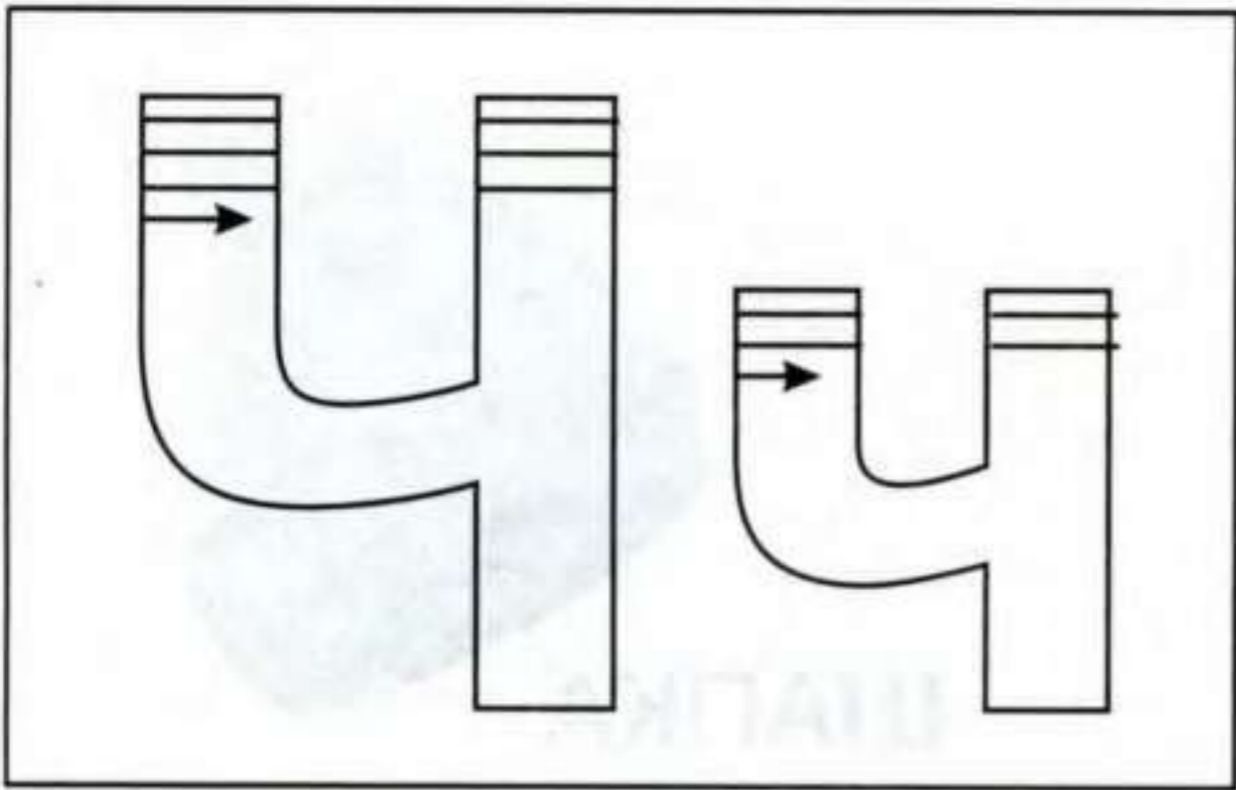

Обведите картинки, в названиях которых есть буква Ч.



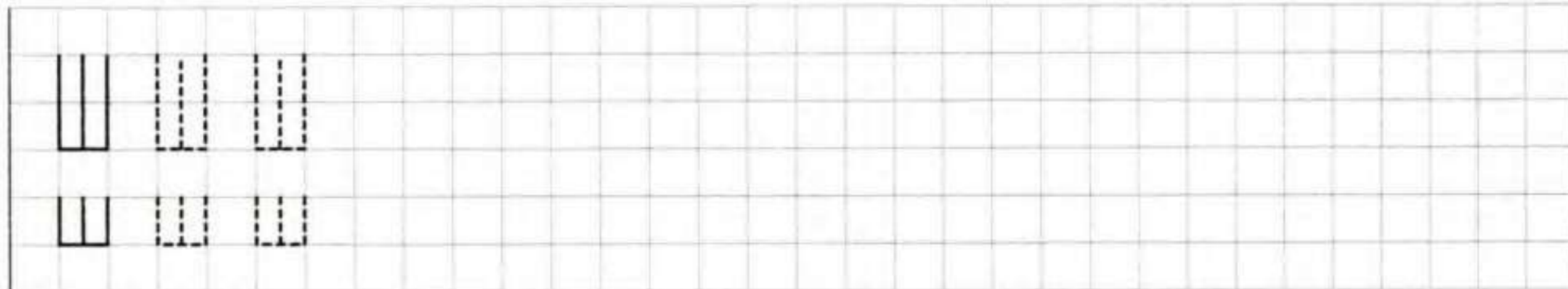
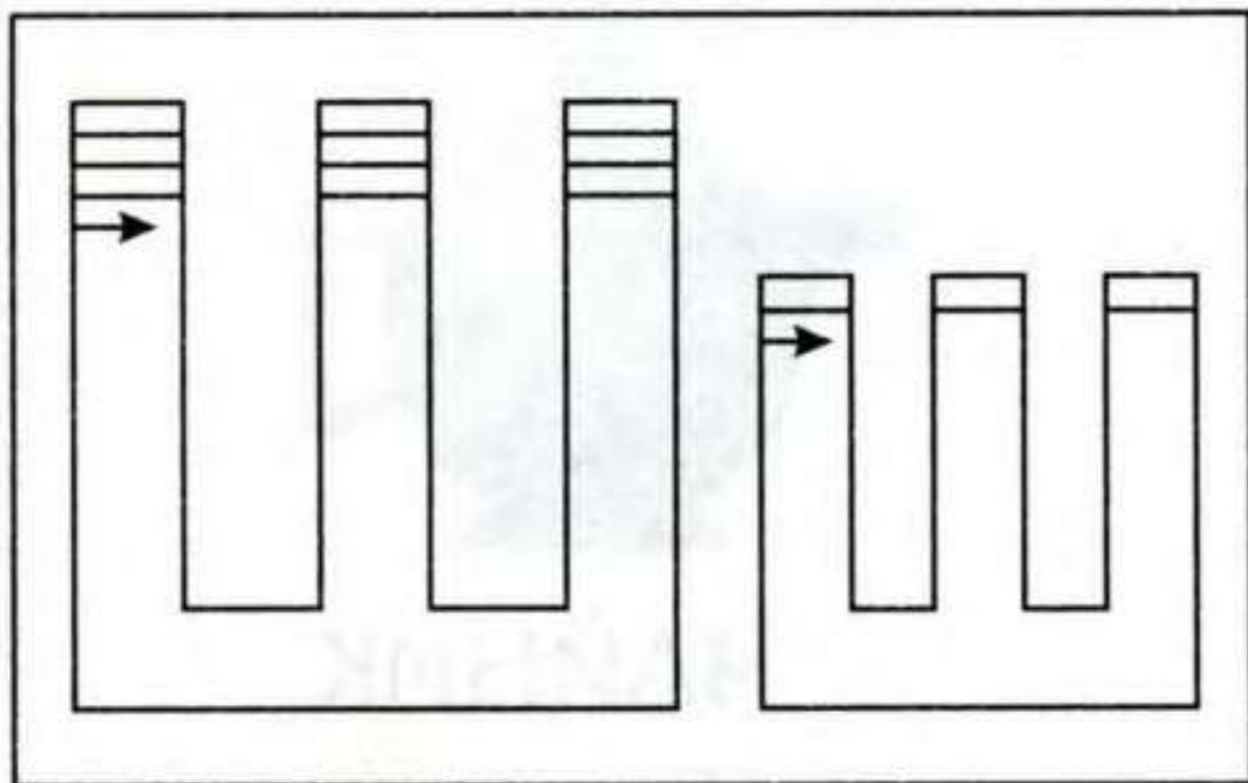

Выбери и раскрась только те картинки в названиях которых есть буква **Ш**.

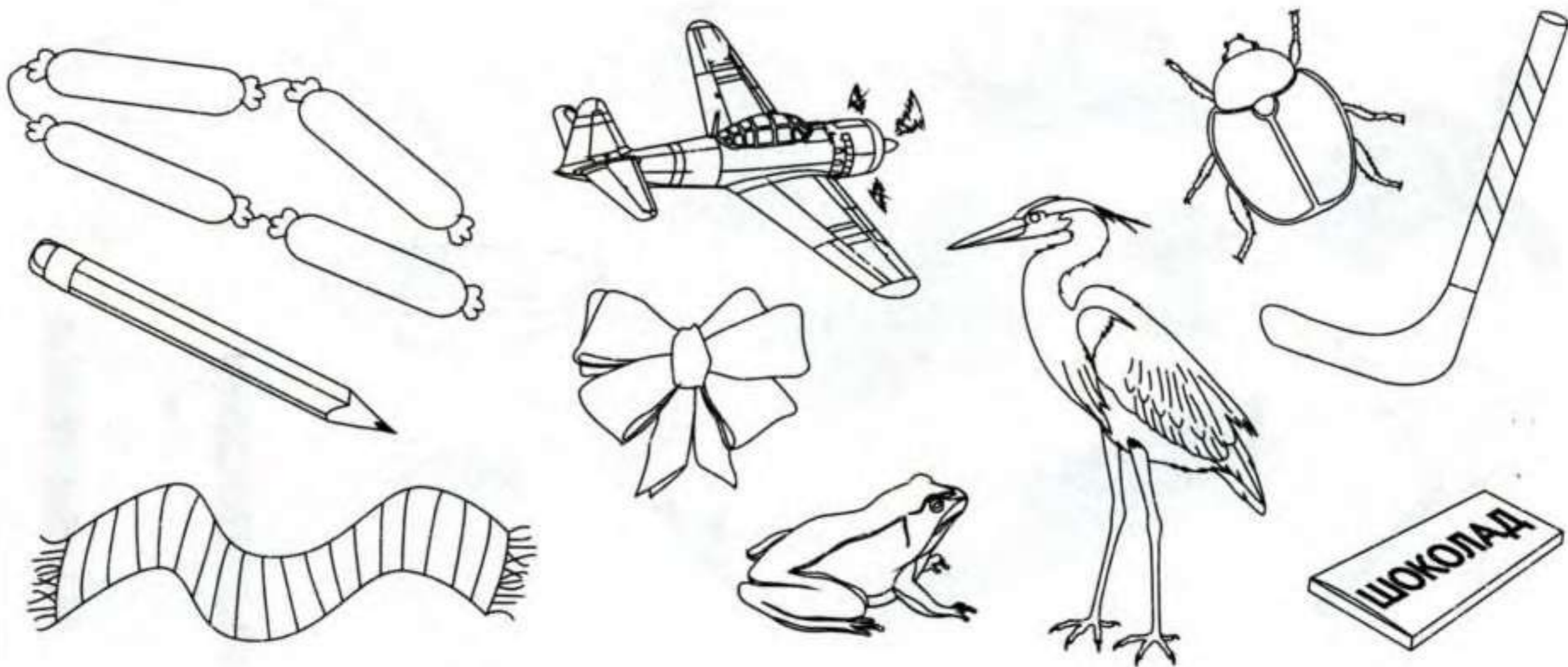

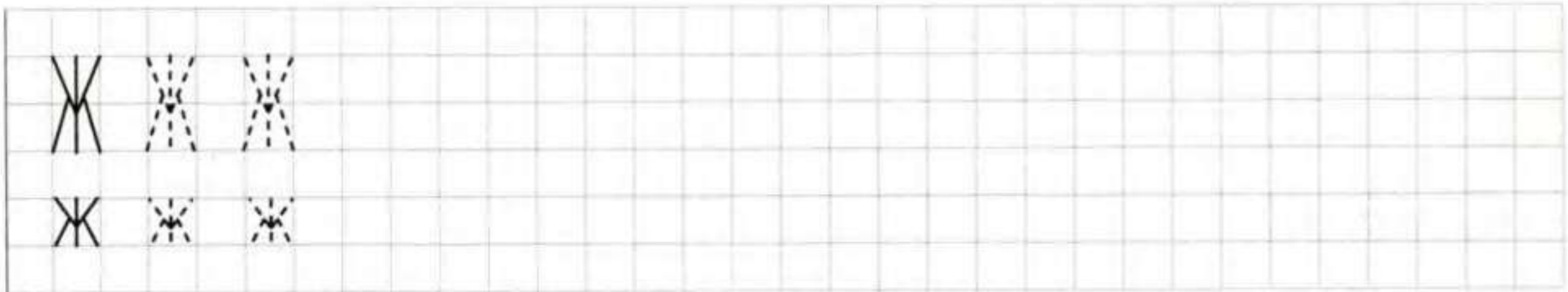
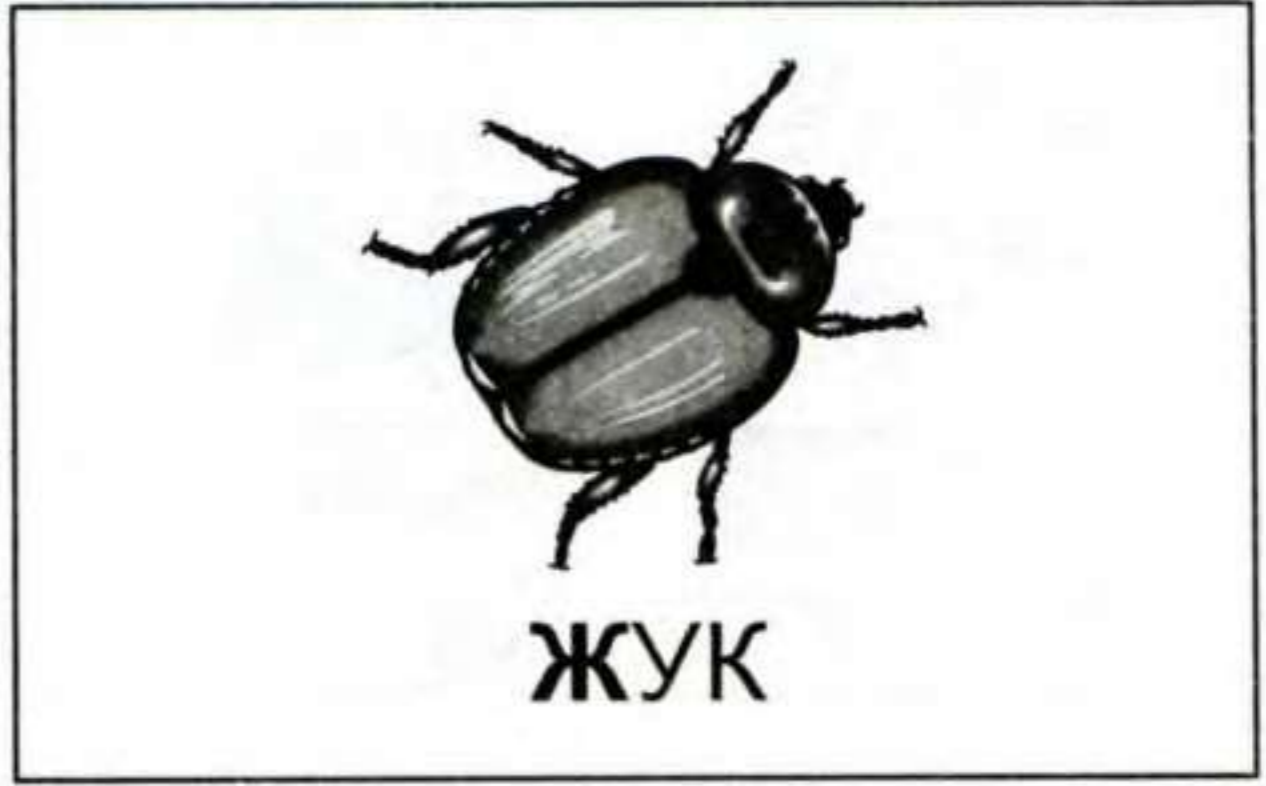
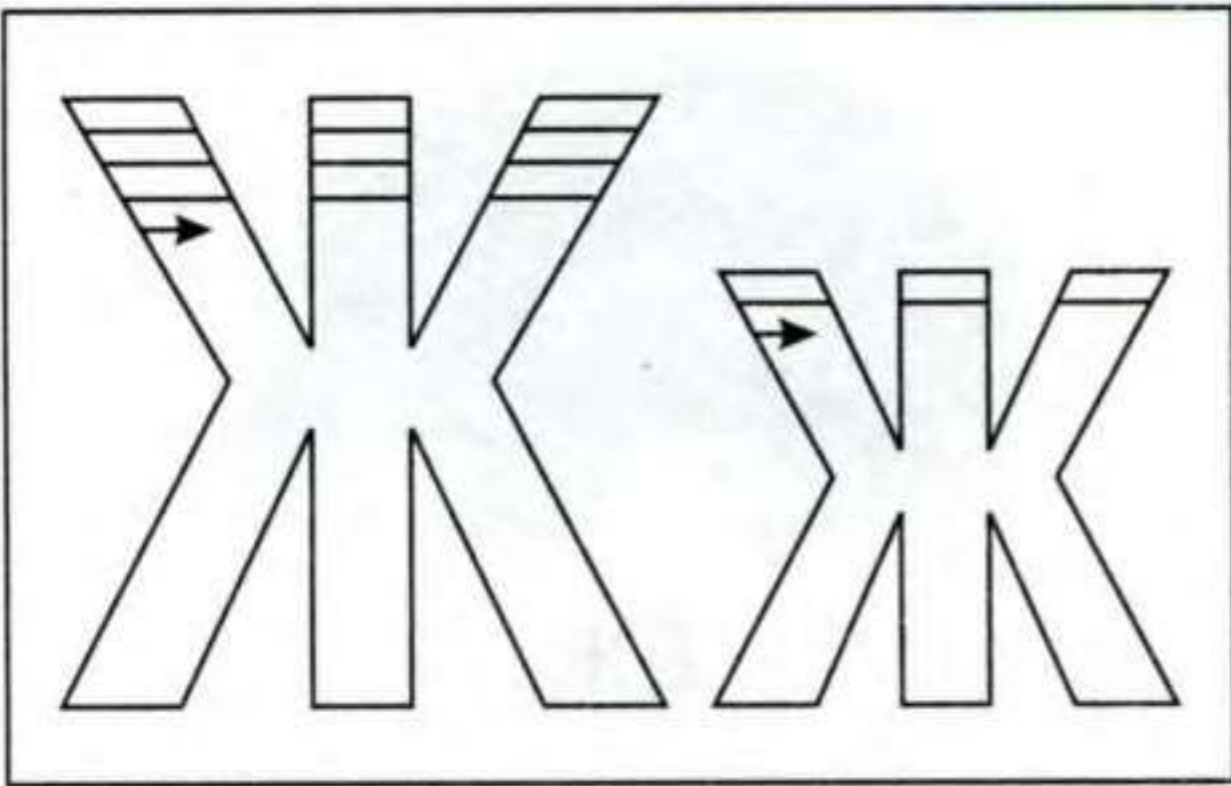

Напиши первую букву, с которой начинается название предмета.

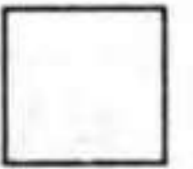
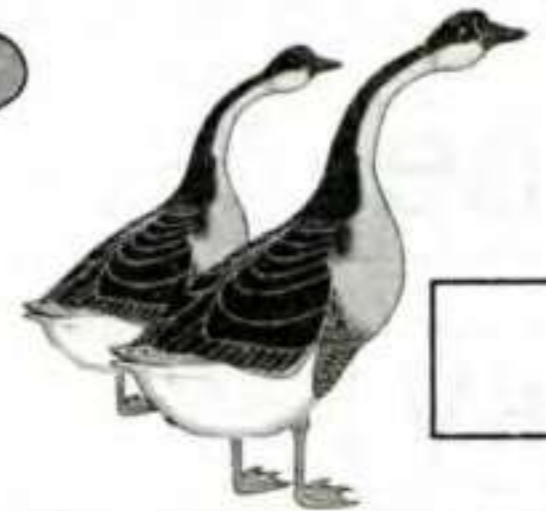
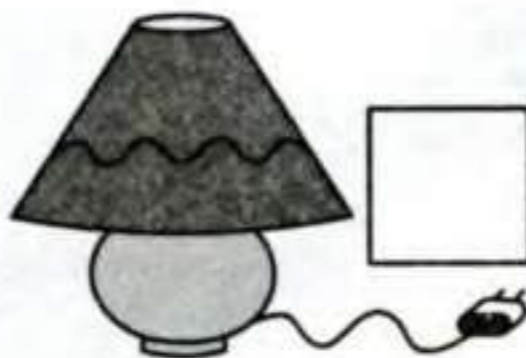
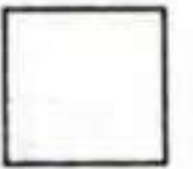
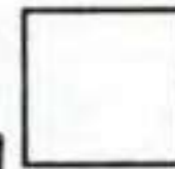
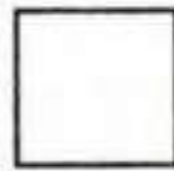

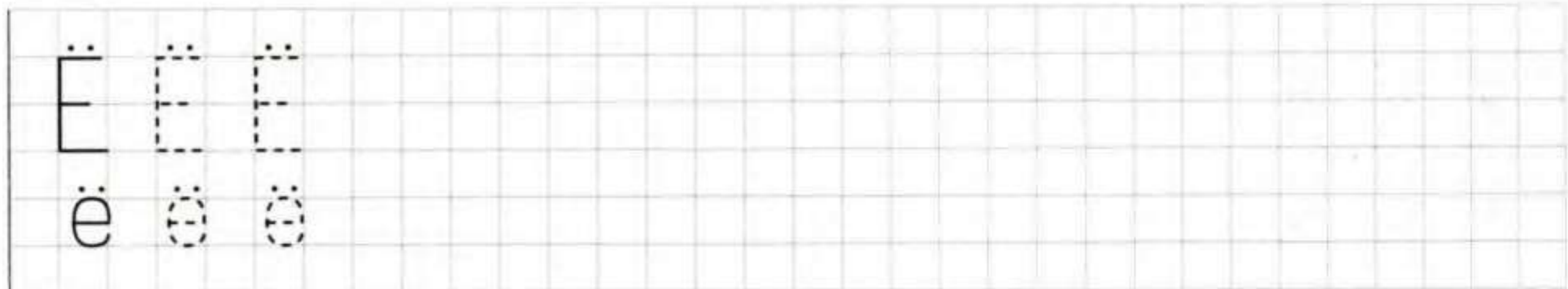
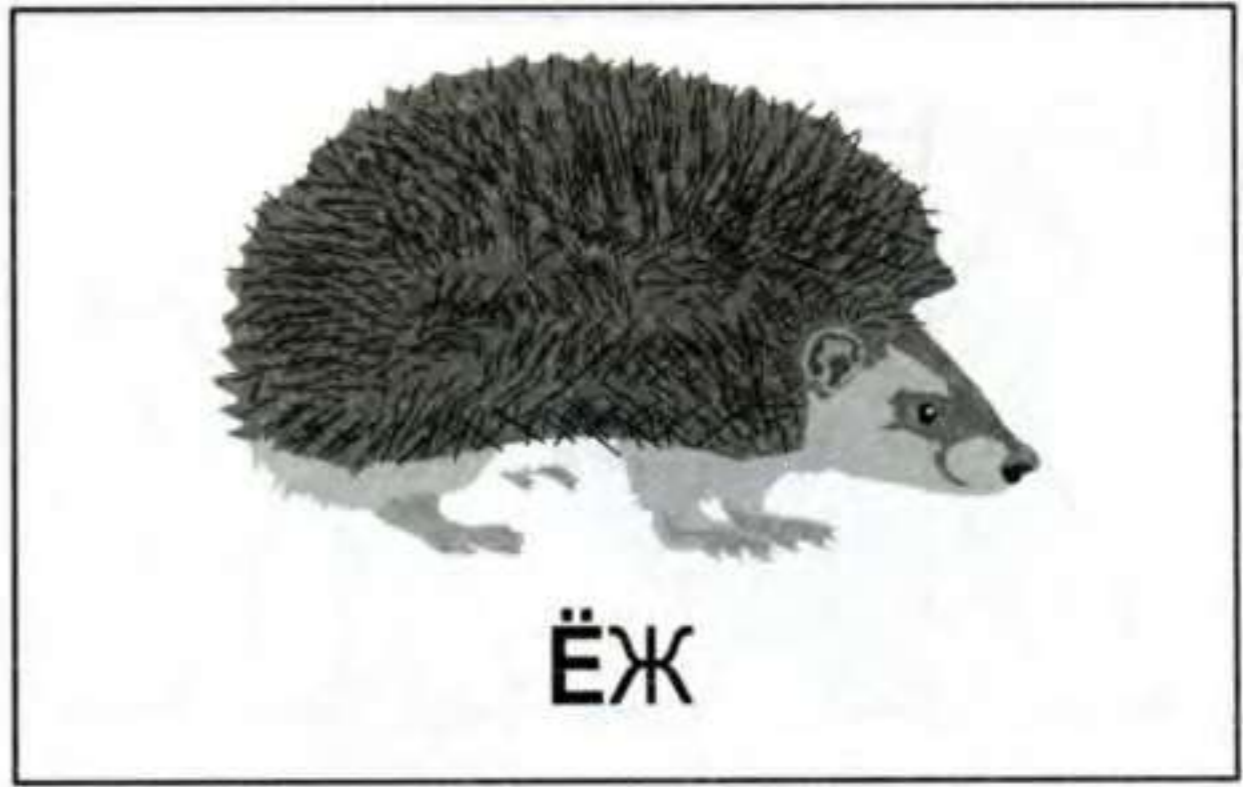
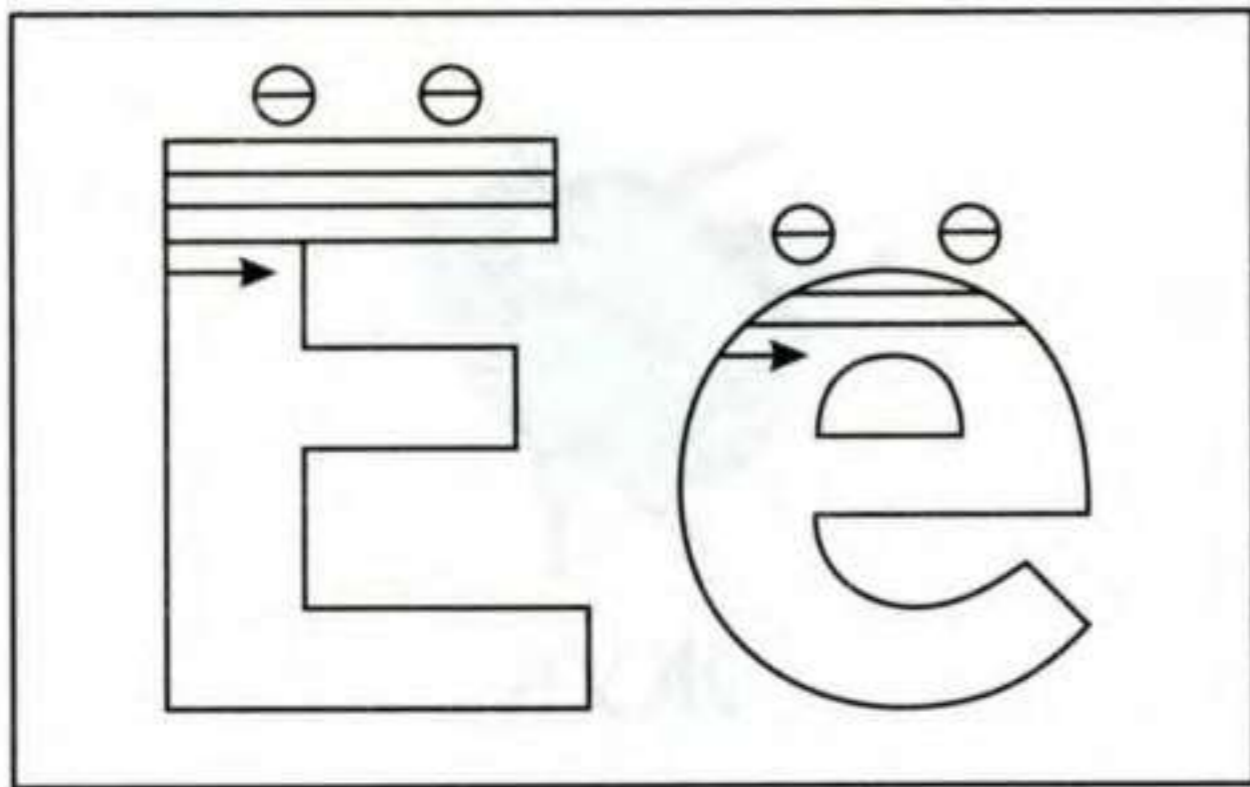

Соедини каждую картинку со слогом, с которого начинается её название.

па

шу

ды

ве

ку



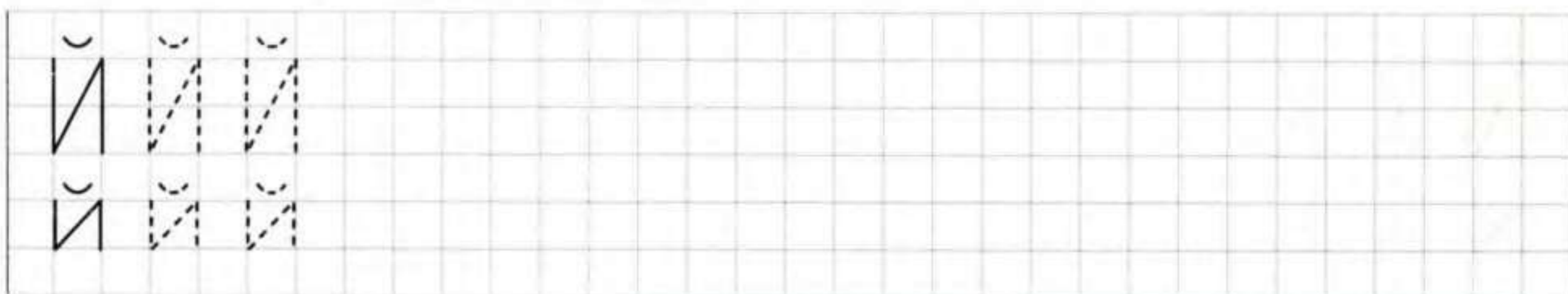
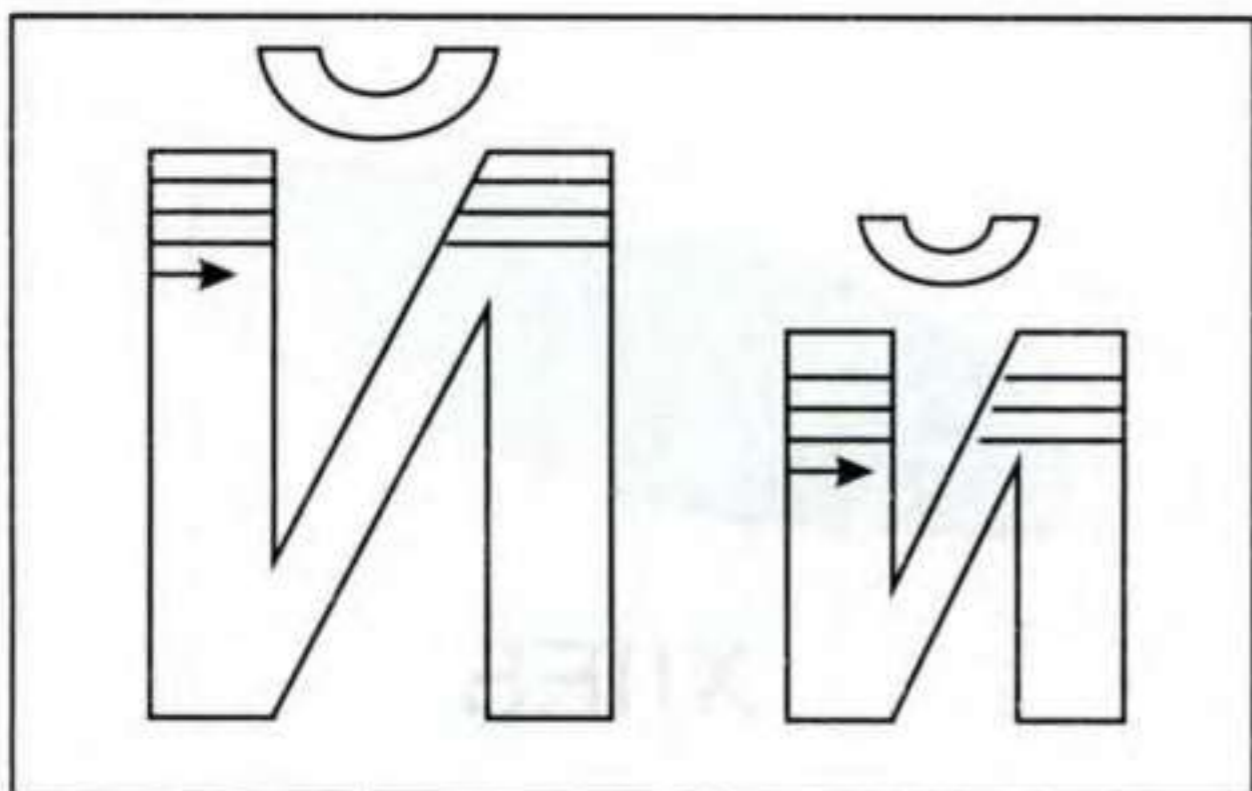

В каком названии предмета буква Й встречается в начале слова, в каком - в середине, а в каком - в конце? Соедини картинку с нужной схемой.

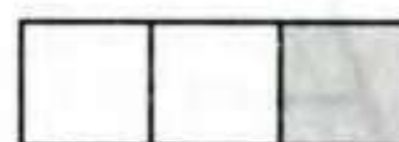
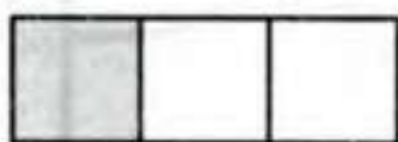

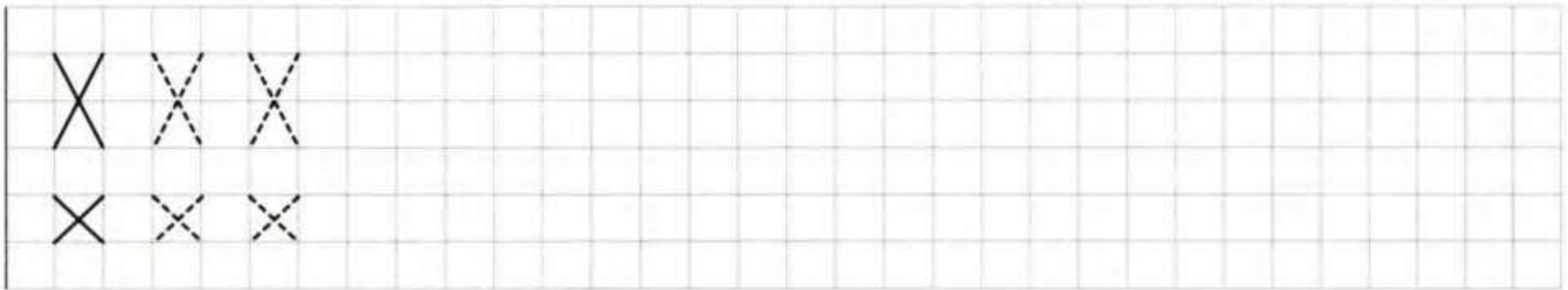
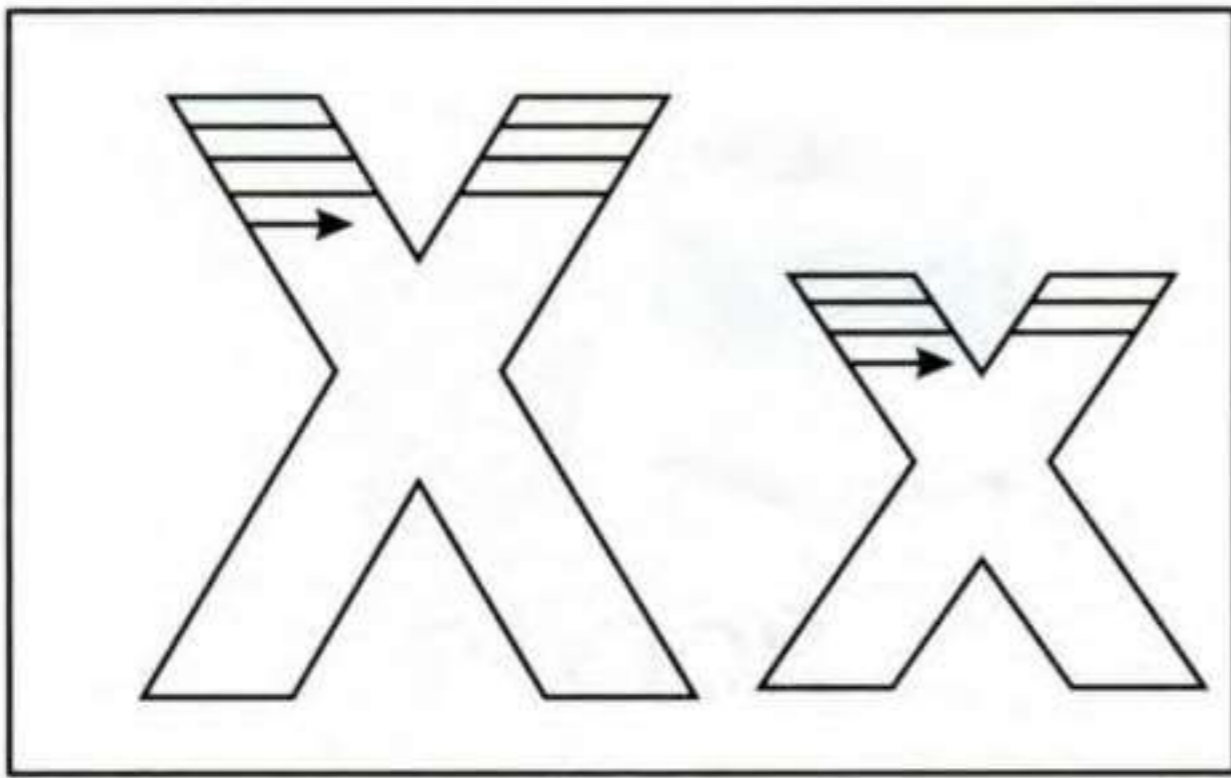

Допиши буквы.

А

Э

У

Р

Ш

У

Г

Т

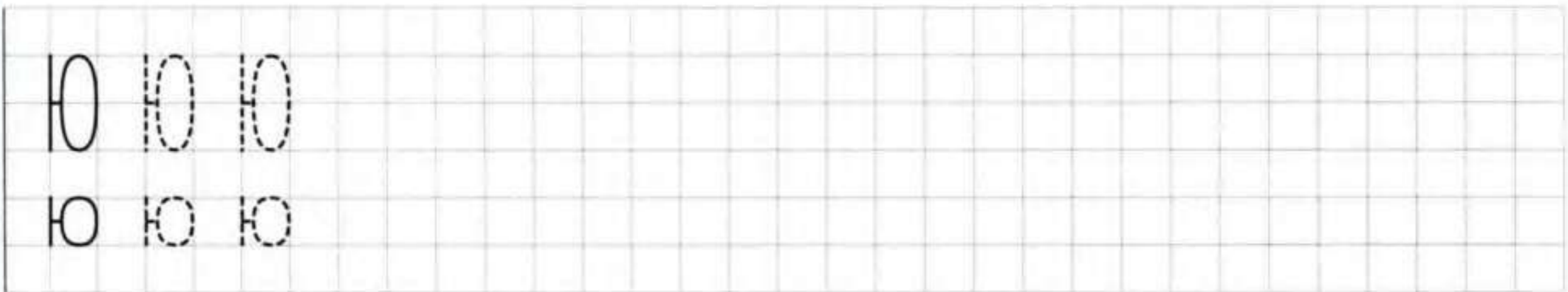
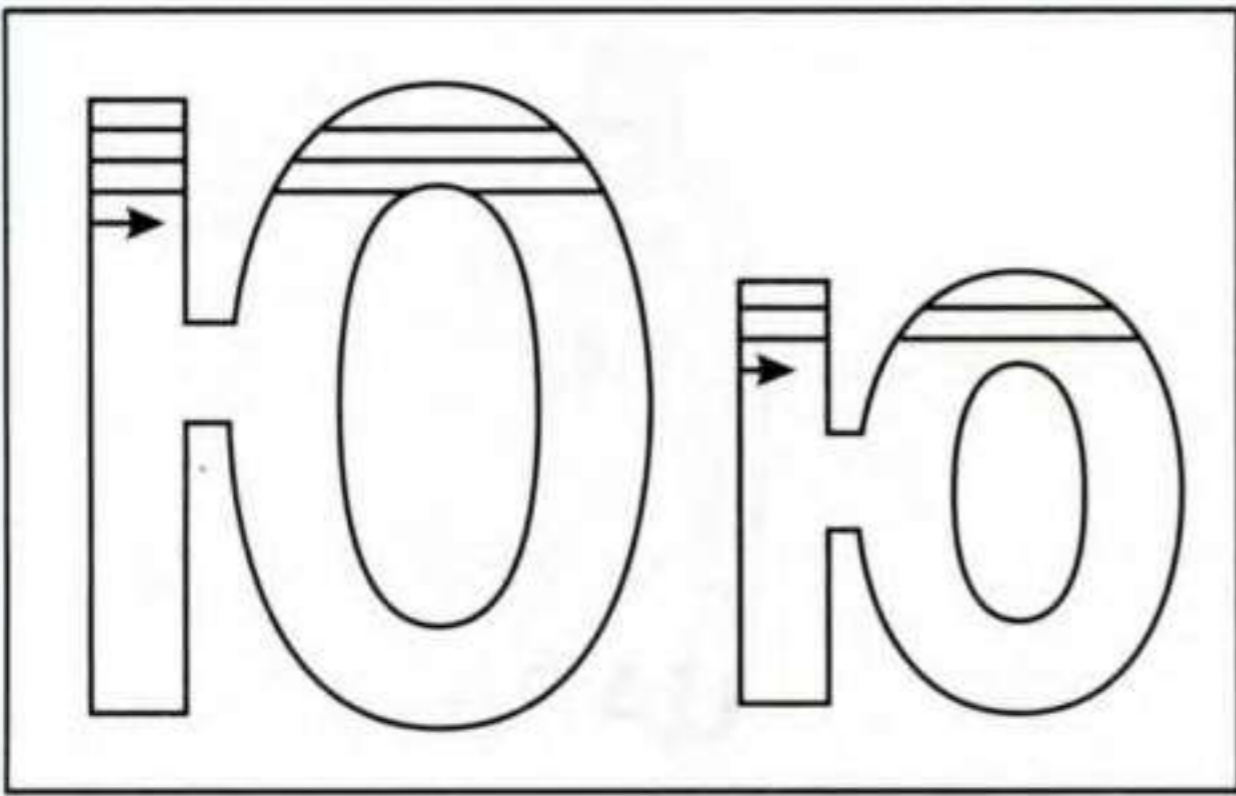

Найди одинаковые буквы в словах и в домиках. Соедини их.

юла



утка

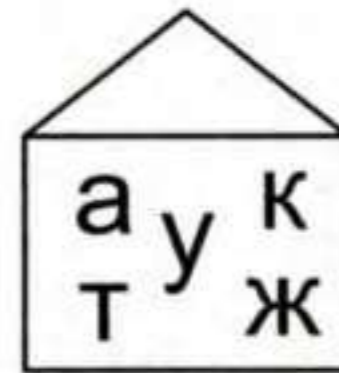

изюм



игра

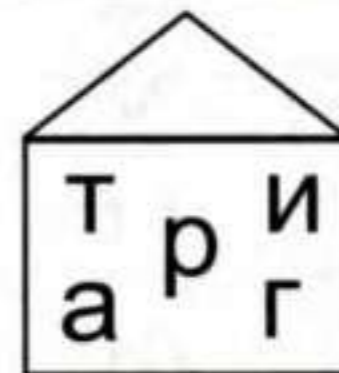

мост



флаг



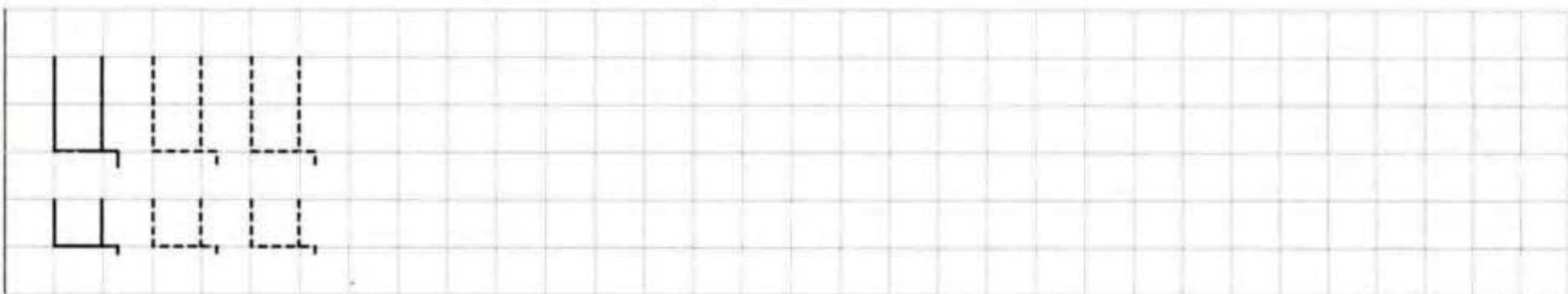
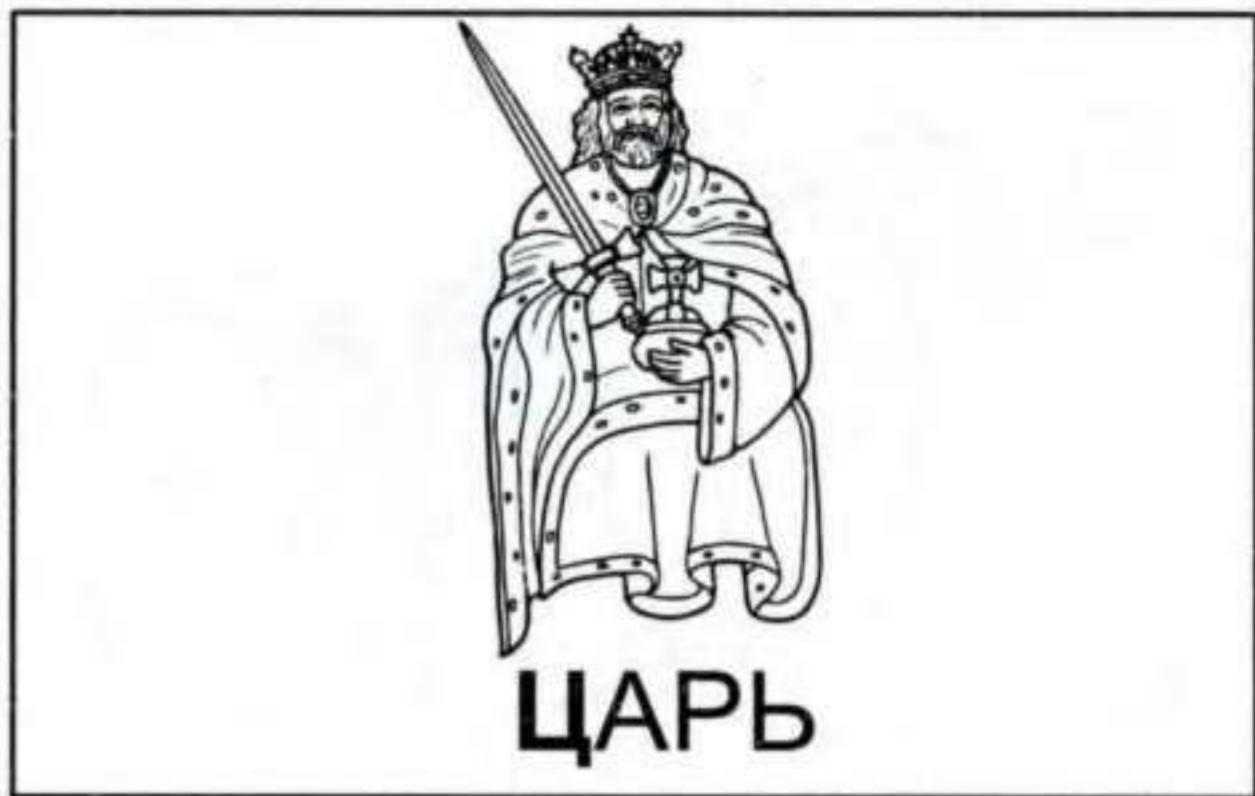
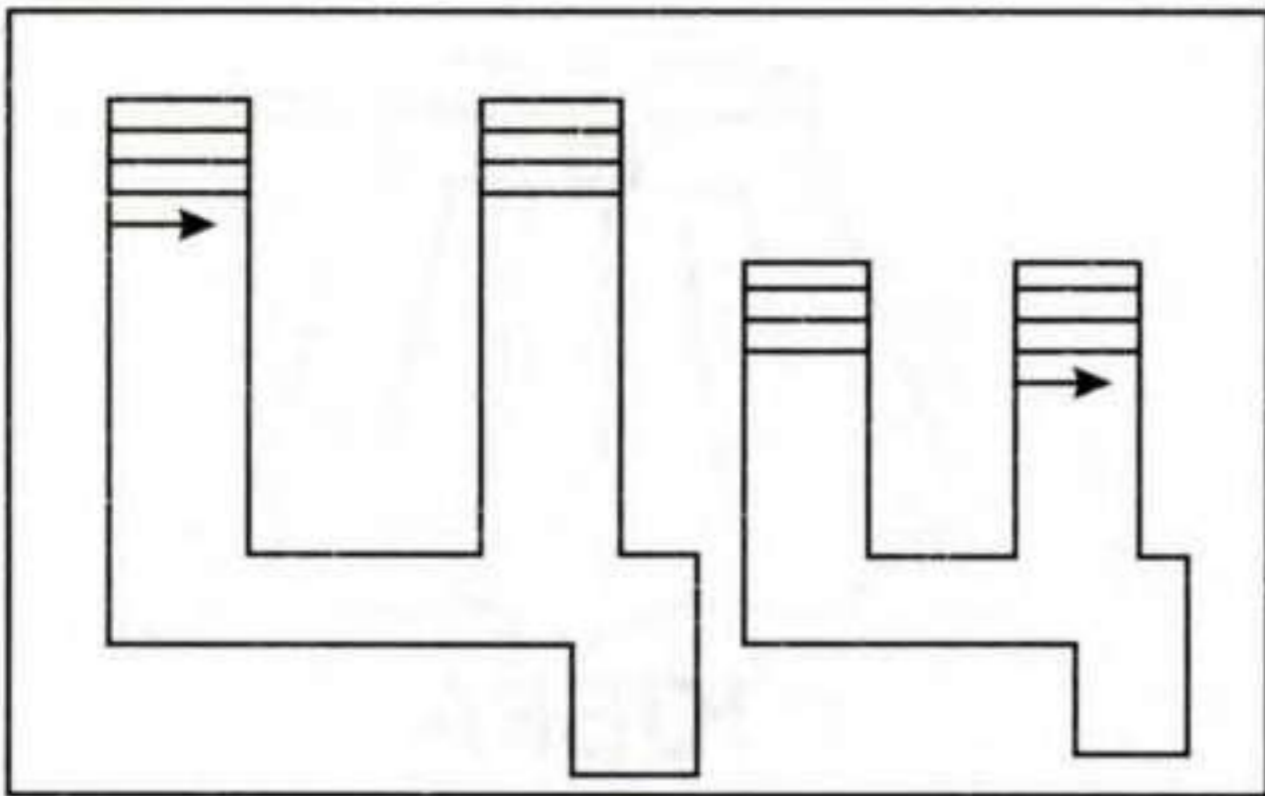

Помоги цыплёнку добраться до мамы.
Проведи его, соединяя все буквы **Ц** линией.

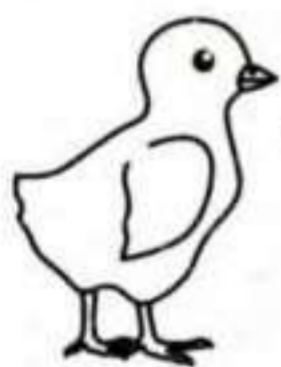

	Ц	К	А	Й	К	Л	О	Р	
О	Я	У	Д	Ц	Ф	В	Д	Я	Ю
Ч	С	Ц	К	Н	Б	Й	З	Х	У
Е	В	Ф	Е	Г	Ц	К	Е	Ы	Я
З	Н	М	У	Л	Д	Ж	Э	С	Ц

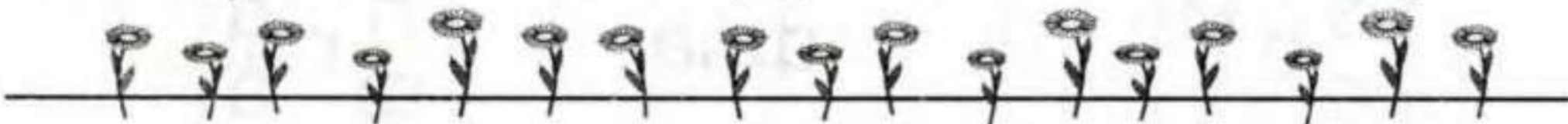
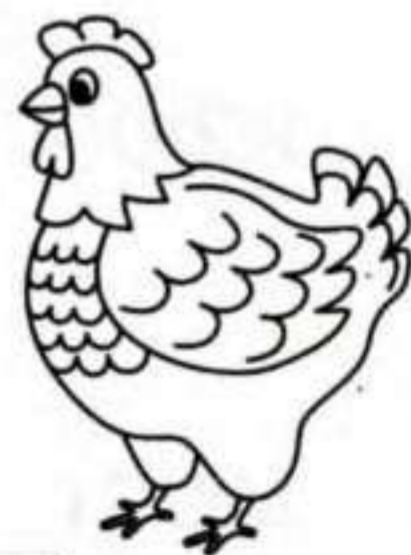

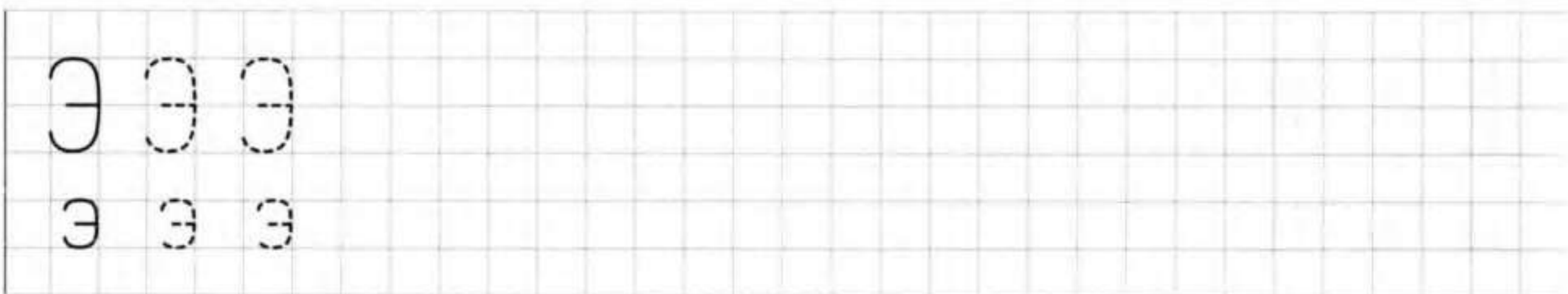
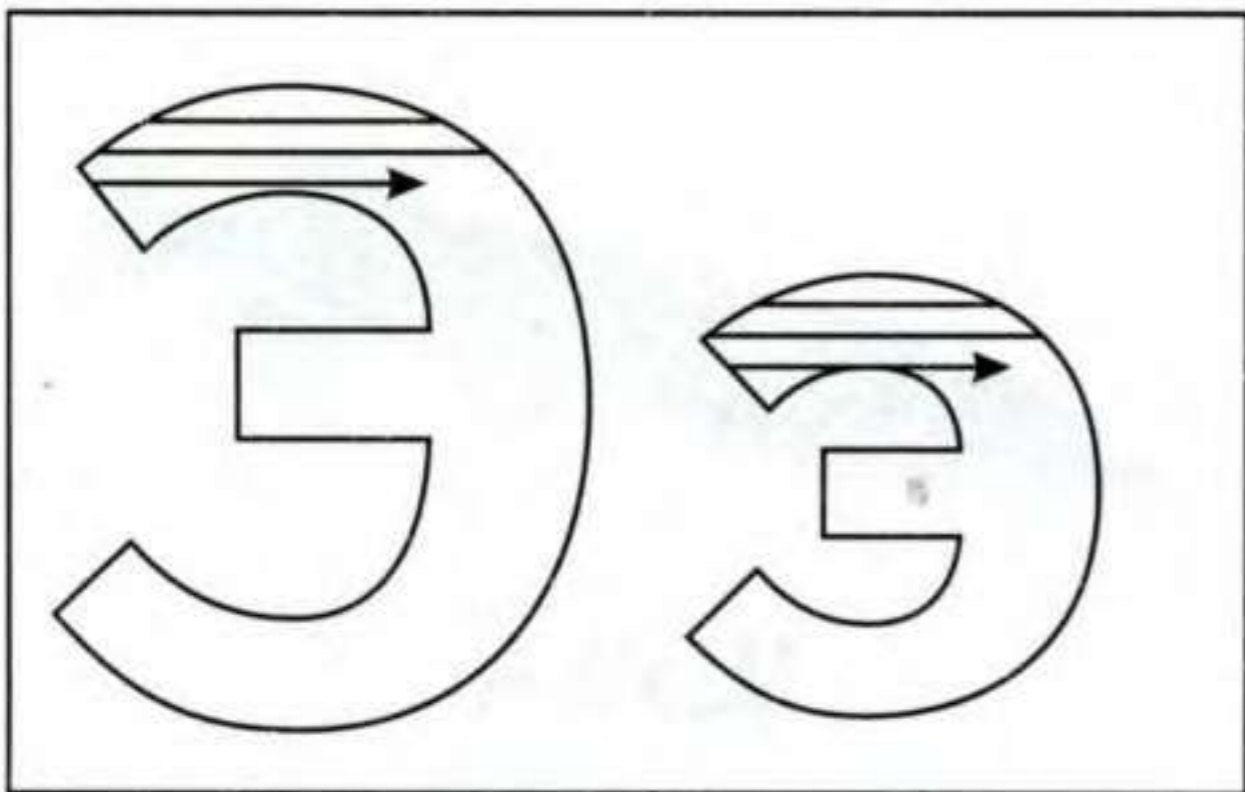

Допиши получившиеся слоги. Прочитай их.

	д	в	ш	с	з	б	л
э	дэ						
е	де						
ы	ды						
и	ди						

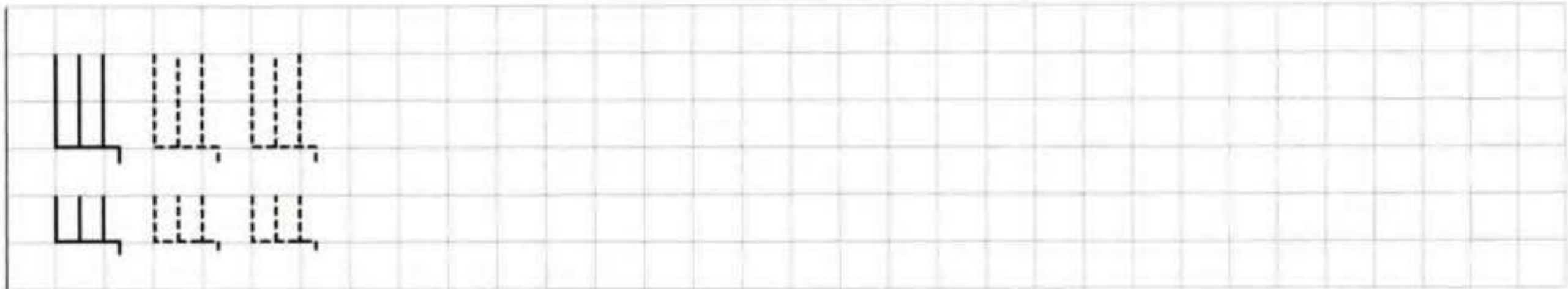
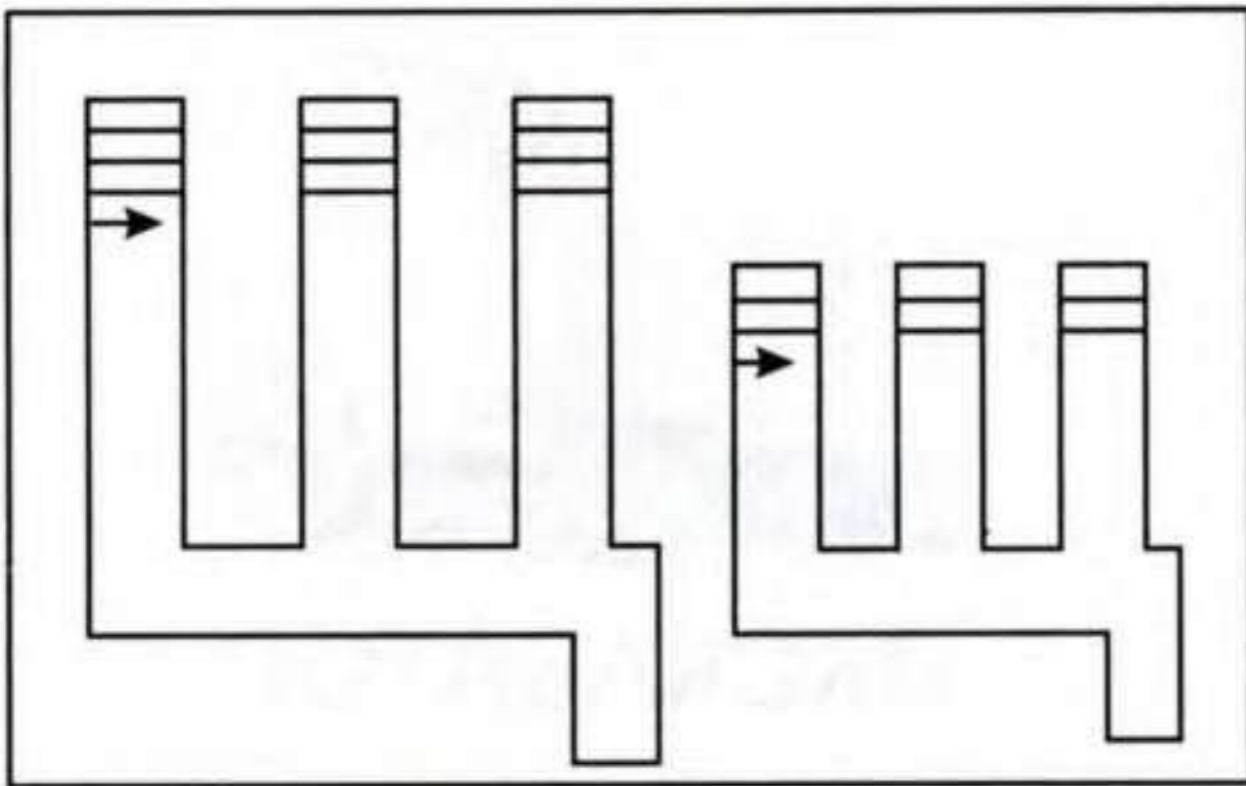

Рассмотри буквы. Зачеркни те, которые написаны неправильно.

А Ш Б Ш Е У

Ю Л Я В Н К

М О Н Р Э С Т

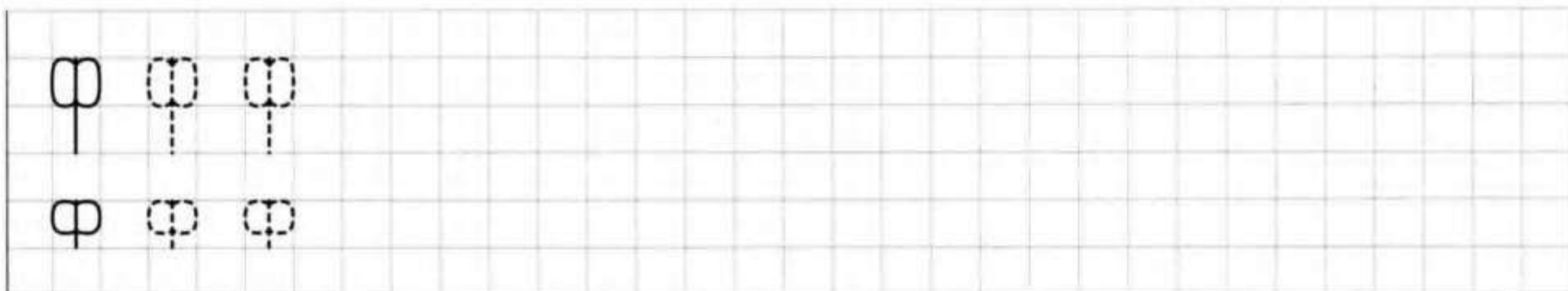
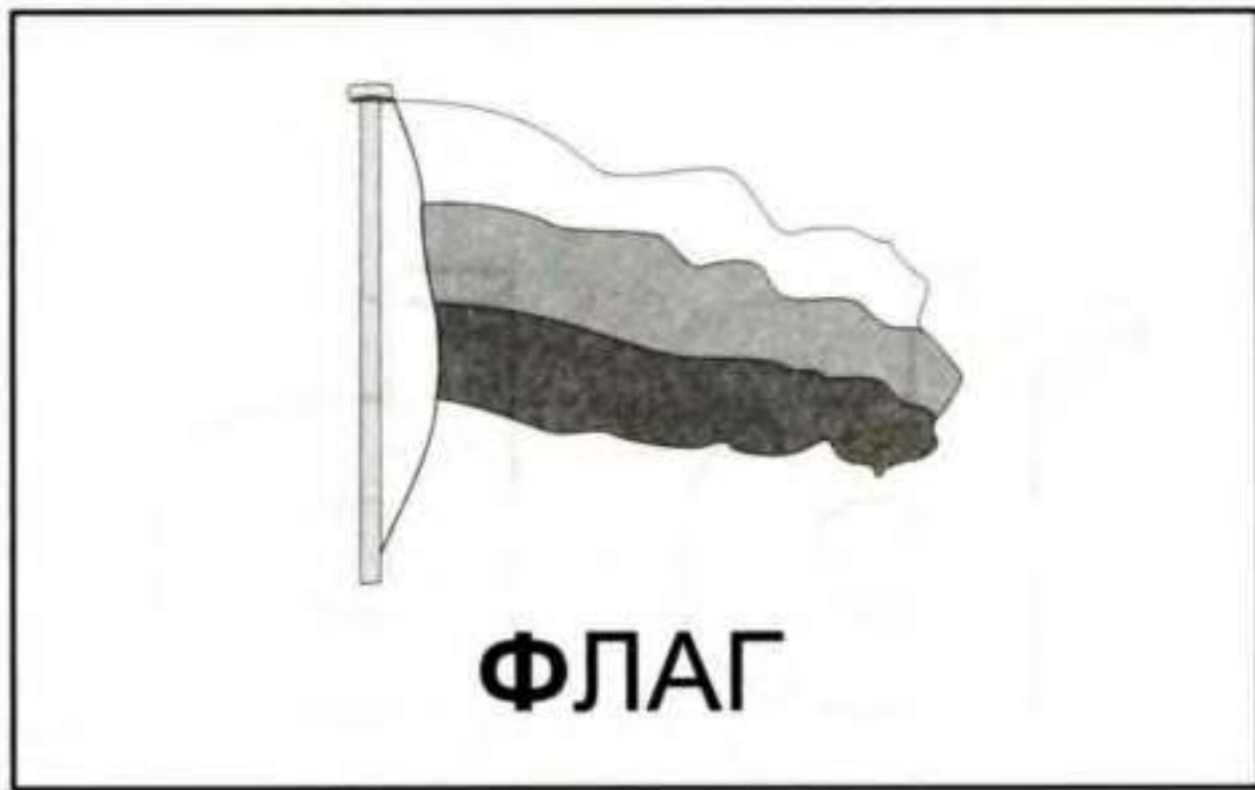
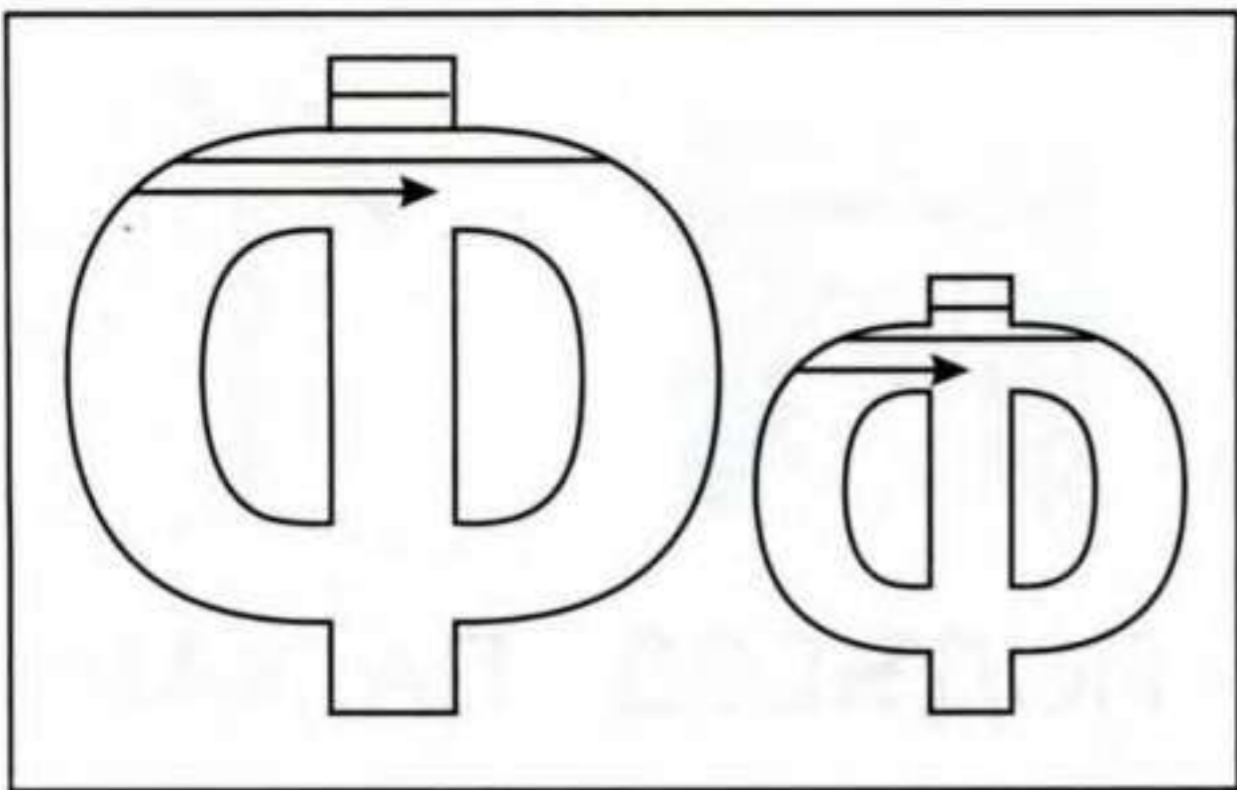

Найди спрятавшиеся буквы на картинке.
Обведи и раскрась.

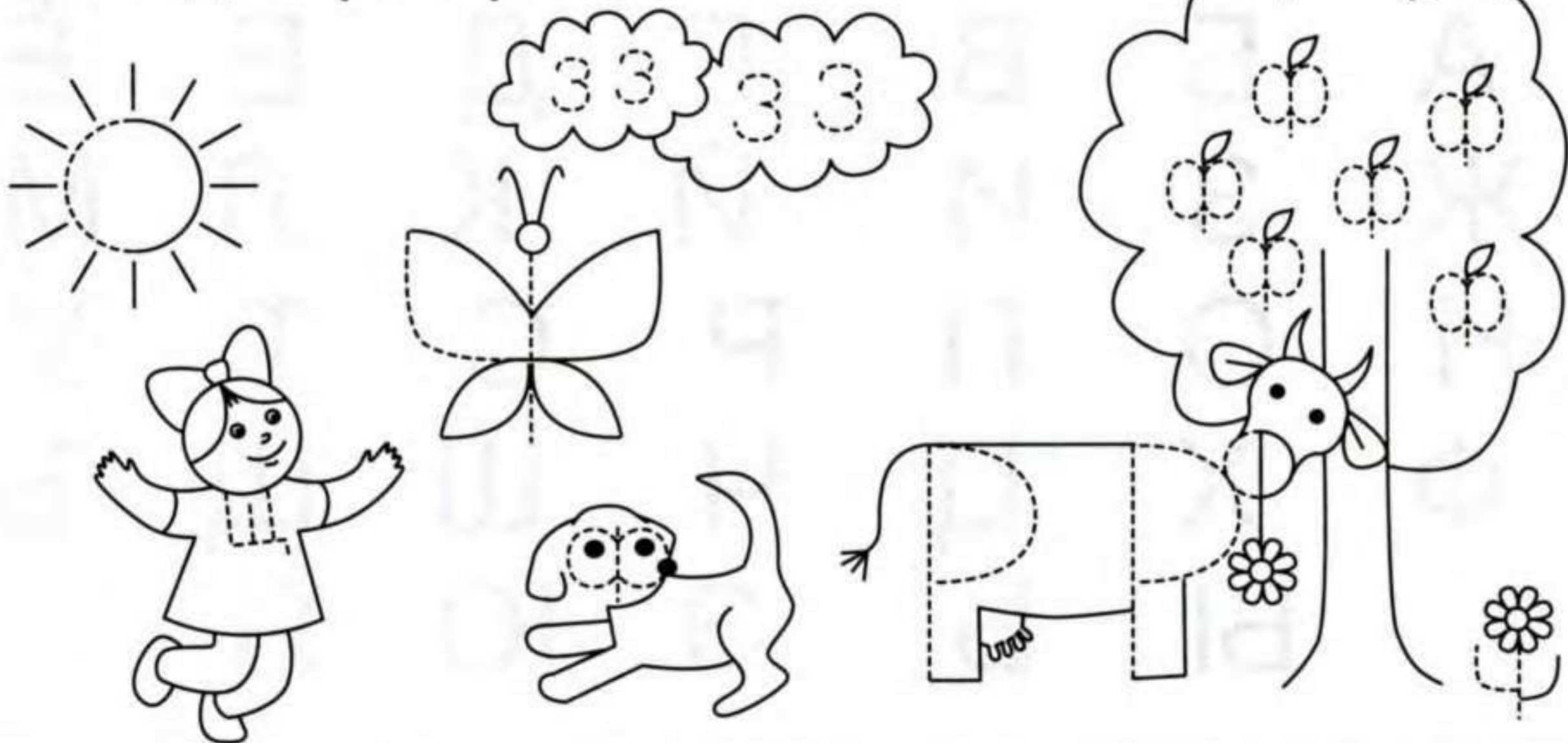

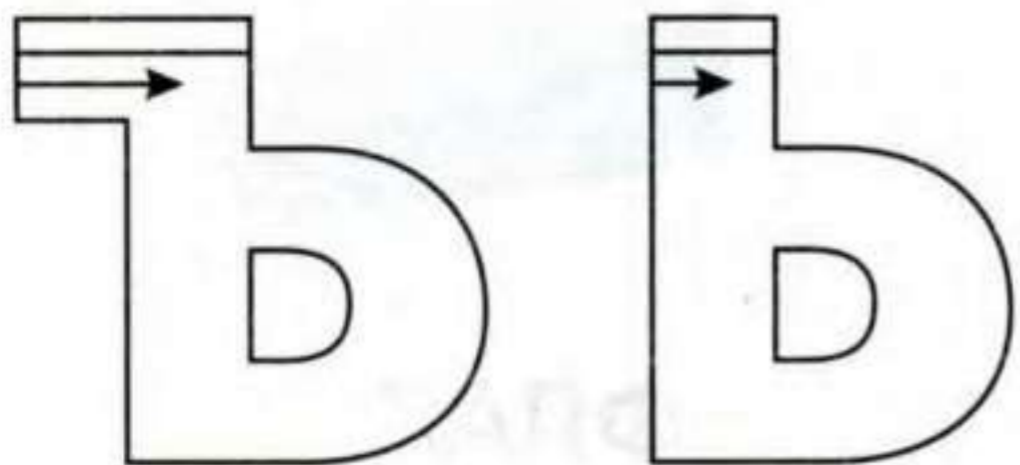

ПОДЪЕЗД



ПАЛЬМА

Б Б Б

б б б

Назови все буквы по порядку.

А	Б	В	Г	Д	Е	Ё
Ж	З	И	Й	К	Л	М
Н	О	П	Р	С	Т	У
Ф	Х	Ц	Ч	Ш	Щ	Ъ
	Ы	Ь	Э	Ю	Я	



Тетрадь для рисования
 Серия « Рабочие тетради дошкольника»
 «Обучение грамоте. Часть 1»
 г. Киров, т. (8332) 32-28-39, 8-912-826-28-01
 E-mail: SSKIROV@yandex.ru

